



C3-540 CORIOmaster™  
C3-510 CORIOmaster mini™  
C3-503 CORIOmaster micro™  
CORIOgrapher™ V3.4 and above

User Guide V2.6

Firmware version M412 and above

PDF-C3-5xx-V2.6

Jun 2022

# In this guide

- Welcome ..... 1
- Get to know your products ..... 2
  - About your CORIOmaster™ ..... 2
  - About your CORIOmaster mini™ ..... 4
  - About your CORIOmaster micro™ ..... 5
    - About the buttons of your CORIOmaster micro™ ..... 6
- About modules ..... 7
  - Input modules ..... 7
  - Output modules ..... 8
  - Audio modules ..... 8
  - Power supply module ..... 8
  - Adapters ..... 9
- About your Streaming media and 4K playback input module ..... 10
- About your HDBaseT input and output module ..... 11
- About your HDMI input and output module ..... 12
- 8HD Player – Synchronized playback mode ..... 13
- FTP Server media synchronization ..... 17
- AES file decryption ..... 19
- About your dual output keying module ..... 20
- About your S/PDIF and analog audio module ..... 22
  - What's breakaway audio? ..... 22
- Hardware recommendations ..... 23
- Get help with your Magenta Encoder-100 ..... 23
- Set it up ..... 24
  - Planning and installing video installations ..... 25
    - Planning a video installation ..... 25
      - What is a window? ..... 26
      - What is a preset? ..... 26
    - Installing your hardware ..... 26
  - Setting up a video installation in CORIOgrapher™ ..... 29
    - CORIOgrapher™ system requirements ..... 29
    - About CORIOgrapher™ ..... 30
    - Getting started with CORIOgrapher™ ..... 31
      - To connect to your CORIOmaster and get its configuration ..... 31
      - To log in with secure mode ..... 31
      - To create a configuration offline ..... 32
      - To send a configuration to your CORIOmaster ..... 32
  - Naming input and output ports and channels ..... 33

Naming the channels of a Streaming media and 4K playback input module .....	33
Enabling secure mode .....	34
About HDCP .....	35
Creating a video installation .....	39
Testing your video installation .....	42
Set up and test audio .....	43
Settings .....	46
Device settings .....	47
Naming your CORIOmaster™ .....	47
Resetting your CORIOmaster™ to factory default settings .....	47
Choosing your working units .....	48
Backing up and restoring your settings .....	48
Backing up your settings on your CORIOmaster .....	48
Restoring your settings from your CORIOmaster .....	49
Backing up your settings to a file on your computer .....	49
Restoring or copying settings from a file on your computer .....	50
Problems sharing settings between CORIOmaster units .....	50
Resetting your CORIOmaster™ to factory default settings .....	50
CORIOmaster micro™ settings .....	51
Configuring the buttons of your CORIOmaster micro™ .....	51
User settings .....	52
Creating and editing users .....	52
What are user roles? .....	52
Why set a timeout time? .....	53
Changing other users' passwords .....	53
Changing your own password .....	54
Network settings .....	54
Configuring network settings for your CORIOmaster™ .....	54
Configuring network settings for streaming media .....	56
About static IP addresses .....	56
To configure network settings for streaming media .....	56
Finding the MAC address of your Streaming media and 4K playback input module .....	57
Playlist settings .....	58
Renaming playlists and moving playlists between modules .....	58
Deleting playlists .....	58
Encoders and streams settings .....	59
Managing encoders and streams .....	59
Resolution Editor .....	61
About custom resolutions .....	61
Creating and editing custom resolutions .....	61
Using your CORIOmaster™ .....	65
Presets .....	65

Creating and editing presets .....	66
What is a preset? .....	66
What is included in a preset? .....	66
What is not included in a preset? .....	66
For best results .....	66
Creating a new preset with all windows .....	68
Creating a new preset with windows that are selected on the canvas .....	68
Creating a new preset and choosing which windows to include .....	69
Edit a preset in the preset editor .....	70
Previewing changes on the device while editing a preset .....	71
Quick edit, overwrite, cloning, and deleting presets .....	72
Loading a preset .....	73
What is a preset? .....	73
Loading a preset from CORIOgrapher .....	73
Loading a preset with the buttons of your CORIOmaster micro .....	74
Show me some preset scenarios .....	75
Adding more windows with existing presets. ....	77
Enabling or disabling the preset window analyzer .....	77
Manually updating presets with the new windows .....	77
Bulk updating presets .....	78
Changing the source playing in a free window .....	79
Changing the source in CORIOgrapher from the Properties panel .....	79
Changing the source in CORIOgrapher from the window .....	79
Changing the source with the buttons of your CORIOmaster micro .....	79
Changing the source using the dashboard .....	80
Using audio .....	81
Playing embedded audio .....	81
About embedded audio .....	82
Disabling and enabling audio for a source or display .....	82
Choosing what to listen to with CORIOgrapher .....	85
What's breakaway audio? .....	85
Choosing which outputs play audio .....	87
Adjusting input audio level and muting sources .....	87
Muting individual audio outputs .....	89
Cutting to black and muting individual outputs .....	89
Adjusting volume and muting all displays and outputs associated with a canvas .....	90
Cutting to black and muting all displays and outputs associated with a canvas .....	91
Controlling audio from the dashboard .....	92
Emergency cut to black and mute .....	92
Playing independent audio with a CORIOmaster micro™ .....	94
About independent audio .....	94
Choosing which window to hear with the buttons of the front panel .....	95

Show me an example .....	95
Choosing which window to hear with CORIOgrapher .....	96
Adjusting the input audio level and muting individual sources .....	96
Muting the audio output .....	97
Media and streams .....	98
Playing media and streams .....	98
Before you start .....	99
Adding and editing media streams .....	99
Adding media items, streams, and playlists to your play queue .....	101
Playing a multicast stream from an Magenta Encoder-100 on multiple CORIOmaster units .....	102
Changing the duration of media items .....	103
Playing streams with low latency .....	104
Using the playback controls .....	105
Managing the play queue .....	106
Saving the play queue .....	107
Show labels for media and streams .....	107
Playing the play queue automatically .....	107
Saving media to internal storage .....	108
Creating and managing playlists .....	109
About playlists .....	109
Creating a new playlist .....	110
Saving the play queue to a playlist .....	111
Managing and editing playlists .....	112
Deleting a playlist .....	114
Moving playlists between modules .....	114
Deleting all playlists .....	114
Duplicating playlists .....	115
Using the internal drive .....	116
Replacing all items on the internal drive with all items on the USB drive .....	116
Removing all items from the internal drive .....	117
Current location .....	117
Copying a single item or folder to the internal drive .....	117
Managing media on the internal drive .....	117
Playing items from the internal drive .....	118
Choosing the best resolution for your playlist or play queue .....	119
Understanding the format of resolution .....	119
How do I know what resolution my media items are? .....	119
Using the buttons of your CORIOmaster micro™ .....	121
Changing between preset and source selection mode with your CORIOmaster micro™ .....	121
Locking your CORIOmaster micro™ .....	121
Replacing a module .....	122

Adding and managing custom EDID files .....	126
Before you start .....	126
Adding a saved EDID file .....	126
Removing EDID files .....	126
Troubleshoot it .....	127
Checking and updating the firmware of your CORIO device .....	128
Checking your firmware version and downloading new firmware .....	128
Updating the firmware .....	129
I can't see my CORIOmaster™ in the Discovered Devices list .....	130
I can't log in to CORIOgrapher™ .....	132
I can't log in securely to CORIOgrapher™ .....	133
The picture keeps coming and going on my CORIOmaster™ .....	135
My Streaming media and 4K playback input module keeps overheating .....	136
I can't hear any audio .....	137
General problems with audio .....	138
Audio from the Streaming media and 4K playback input module .....	142
Audio from the S/PDIF output of a CORIOmaster micro .....	143
If that doesn't work .....	144
I can't update the firmware of my Streaming media and 4K playback input module .....	145
General troubleshooting checklist .....	146
Returning a product for repair .....	146
What are the minimum requirements for running CORIOgrapher? .....	146
What's the password for my CORIOmaster™? .....	147
Can I use HDMI extenders with CORIOmaster™ output modules? .....	147
Where can I put Streaming media and 4K playback input modules? .....	147
How large is the internal storage on a Streaming media and 4K playback input module? .....	147
How do I find the MAC address of my Streaming media and 4K playback input module? .....	147
How fast is my connection to the Streaming media and 4K playback input module? .....	148
Which media formats can I add to a play queue? .....	148
Can I save my play queue? .....	148
How do I mute audio? .....	148
More .....	149
What's new in CORIOgrapher™ V3.4 for CORIOmaster™ .....	149
Regulatory compliance for CORIOmaster™, CORIOmaster mini™, CORIOmaster micro™, Magenta Encoder-100, and all modules .....	149
Contact us .....	150

# Welcome

Welcome to tvONE Help, the place to get help with your:

- CORIOmaster™
- CORIOmaster mini™
- CORIOmaster micro™
- CORIOgrapher™



Get more help

You can read more online. To open the online help, select ? Help in CORIOgrapher, or visit [help.tvone.com/r/docs/cm/home/1](http://help.tvone.com/r/docs/cm/home/1).

## Meet CORIOmaster

Thanks for buying this CORIOmaster, CORIOmaster mini, or CORIOmaster micro. CORIOmaster connects to a wide range of sources and displays, and works with CORIOgrapher software to allow you to build dynamic video walls with an easy-to-use visual interface.

- »» Output up to four video walls to monitors, LED screens, and projectors, including devices that support 4K
- »» Wide range of inputs, including HDMI, DVI, SDI, HDBase™, 4K, and streaming media
- »» Wide range of outputs including HDMI, DVI, SDI, HDBase™, 4K and keying
- »» Embedded and S/PDIF audio support with S/PDIF audio module
- »» S/PDIF audio output with CORIOmaster micro
- »» Combination of different size and resolution of displays can be used
- »» Adjustable bezel compensation
- »» Edge blending of projectors
- »» Up-down-cross conversion
- »» Control your video wall with CORIOgrapher, secure IP, or serial connection
- »» HTTP and HTTPS connectivity, RESTful multi-user control, WebSocket event monitoring
- »» Horizontal alignment on analog PC inputs
- »» Crestron module available
- »» CORIOmaster: 4RU frame size
- »» CORIOmaster mini: 1RU frame size
- »» CORIOmaster micro: 1RU half rack size, up to two video walls

## Meet CORIOgrapher

CORIOgrapher V3.4 is packed with features to help you create and manage your video walls.

- »» Simple, powerful, software interface
- »» Save window configurations as presets and transition between presets
- »» Rotate outputs in 1° increments
- »» Choose sources for windows
- »» Manage streaming media
- »» Use custom resolutions
- »» Manage EDID data
- »» See your changes instantly with live changes mode
- »» Undo and redo your work
- »» Control audio
- »» Configure labels, borders, and colors
- »» Position your displays and windows with pixel-precision

# Get to know your products

Learn about the features and functions of your hardware.

## In this section

- About your CORIOmaster™ ..... 2
- About your CORIOmaster mini™ ..... 4
- About your CORIOmaster micro™ ..... 5
  - About the buttons of your CORIOmaster micro™ ..... 6
- About modules ..... 7
  - About your Streaming media and 4K playback input module ..... 10
  - About your HDBaseT input and output module ..... 11
  - About your HDMI input and output module ..... 12
  - 8HD Player – Synchronized playback mode ..... 13
  - FTP Server media synchronization ..... 17
  - AES file decryption ..... 19
  - About your dual output keying module ..... 20
  - About your S/PDIF and analog audio module ..... 22
- Hardware recommendations ..... 23
- Get help with your Magenta Encoder-100 ..... 23

## About your CORIOmaster™

CORIOmaster connects to a wide range of sources and displays, and works with CORIOgrapher™ software to allow you to build dynamic video walls with an easy-to-use visual interface.

### Slots

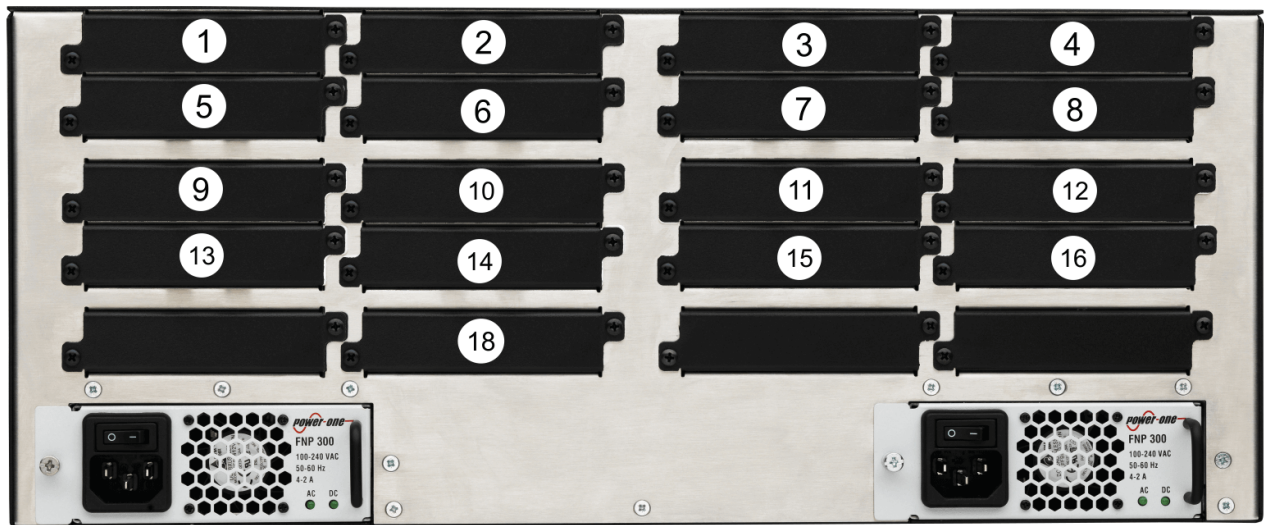

Your CORIOmaster has 16 slots that can contain input or output modules. You can have up to 14 input modules and up to 14 output modules. Of the 14 input modules, up to five can be Streaming media and 4K playback input modules. You can only have one S/PDIF and analog audio module.

In a CORIOmaster, slots 1 and 2 can only contain input modules, and slots 15 and 16 can only contain output modules. Only slots 4, 8, 5, 1, and 3 can contain Streaming media and 4K playback input modules. Install Streaming media and 4K playback input modules in the order shown here. Only slot 18 can contain a S/PDIF and analog audio module.



We recommend that you group your modules. Add input modules from slot 1 upwards, and add output modules from slot 16 downwards.

## CORIOmaster rear panel



- |          |                                      |   |
|----------|--------------------------------------|---|
| <b>A</b> | Input module (black)                 | Connect to sources  |
| <b>B</b> | Output module (white)                | Connect to displays   |
| <b>C</b> | CPU module                           | Connect to your network with Ethernet<br>Optional: connect to serial controller with RS-232<br>Optional: connect directly to a PC with Ethernet or RS-232 |
| <b>D</b> | Optional second PSU, sold separately | Optional: connect to electrical outlet  |
| <b>E</b> | Sealed slots                         | Not available for use   |
| <b>F</b> | Power supply unit (PSU)              | Connect to electrical outlet  |

## About your CORIOmaster mini™

This guide uses the name CORIOmaster to mean CORIOmaster™, CORIOmaster mini™, and CORIOmaster micro™ systems, unless specifically stated.

### Slots



Your CORIOmaster mini has six slots that can contain input or output modules. You can have up to five input modules and up to five output modules. Of the five input modules, up to two can be Streaming media and 4K playback input modules.

In a CORIOmaster mini, slot 6 can only contain an input module. Only slots 1 and 2 can contain Streaming media and 4K playback input modules.

- ! Risk of poor performance  
Avoid fitting an input module in slot 4.

### CORIOmaster mini rear panel

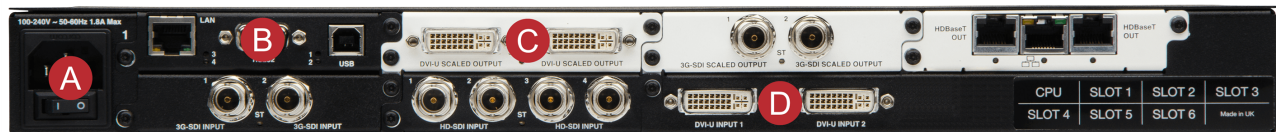

- A** Power supply unit (PSU) Connect to electrical outlet
- B** CPU module  
Connect to your network with Ethernet  
Optional: connect to serial controller with RS-232  
Optional: connect directly to a PC with Ethernet or RS-232
- C** Output module (white) Connect to displays
- D** Input module (black) Connect to sources  
Note: slot 6 is a fixed input slot, included with every CORIOmaster mini.

## About your CORIOmaster micro™

This guide uses the name CORIOmaster to mean CORIOmaster™, CORIOmaster mini™, and CORIOmaster micro™ systems, unless specifically stated.

### Slots



Your CORIOmaster micro has three slots that can contain input or output modules. You can have up to two input modules and up to two output modules.

### CORIOmaster micro rear panel



- |          |                       |   |
|----------|-----------------------|---|
| <b>A</b> | S/PDIF audio output   | Connect to audio device with RCA  |
| <b>B</b> | Power supply input    | Connect to an electrical outlet with PSU  |
| <b>C</b> | Input module (black)  | Connect to sources  |
| <b>D</b> | Output module (white) | Connect to displays   |
| <b>E</b> | CPU module            | Connect to your network with Ethernet<br>Optional: connect to serial controller with RS-232<br>Optional: connect directly to a PC with Ethernet or RS-232 |

### CORIOmaster micro mounting accessories

You can mount your CORIOmaster micro to a surface, rack, or ONERack system with our mounting accessories, sold separately. Ask your distributor about:

- RM-660 - Dual Rackmount kit for 1U, half rack wide products.
- RM-661 - Single Rackmount kit for 1U, half rack wide products including shelf.
- RM-601 - Surface Mounting kit for 1U, half rack wide products.

## About the buttons of your CORIOmaster micro™

You can use the buttons of the front panel to load presets, choose which window to hear, change the source playing in a window, and lock the buttons.

By default, the buttons correspond to the first eight presets, sources, or windows in your system. You can choose which button corresponds to which preset, source, or window.

Read more about mapping the buttons of your CORIOmaster micro on page 51.

The buttons light up different colors depending on the mode and status of your CORIOmaster micro.

### Colors of buttons

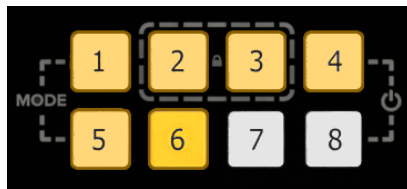

Buttons are lit dimly orange      The CORIOmaster micro is in preset selection mode.

Button 6 is lit more brightly      The preset corresponding to button 6 is active.

Buttons 7 and 8 are not lit      Buttons 7 and 8 do not have corresponding presets.

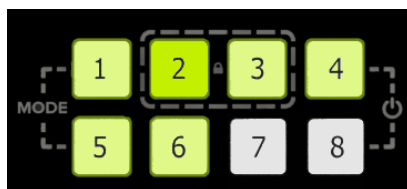

Buttons are lit dimly green      The CORIOmaster micro is in source selection mode.

Button 2 is lit more brightly      The source corresponding to button 2 is playing in the active window. You hear the audio from the active window.

Buttons 7 and 8 are not lit      Buttons 7 and 8 do not have corresponding sources.

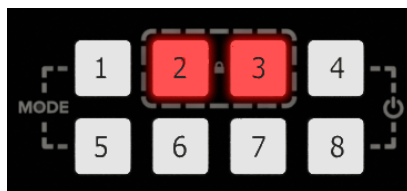

Buttons 2 and 3 are lit red      The buttons of the CORIOmaster micro are locked.

### Selecting the active window

- To select the active window, press and hold the button corresponding to that window until it starts flashing.

### Selecting a window to hear

You hear the audio source playing in the active window on the device connected to the S/PDIF output.

- To select a window to hear, press and hold the button corresponding to that window until it starts flashing.
- You can play audio on any connected display or device with CORIOgrapher.

### Selecting a preset or source

- To select a preset or source, press and release the button corresponding to that preset or source.

## Changing between preset and source selection mode

- Press and hold buttons 1 and 5 until they start flashing.  
The buttons change color.

## About modules

CORIOmaster™, CORIOmaster mini™, and CORIOmaster micro™ supports the following modules. Each module supports specific connections, but our range of adapters means you can connect almost any type of source or display to your CORIOmaster.

CORIOview™ supports the following modules. You can have one output module, and up to two input modules. Each module supports specific connections, but our range of adapters means you can connect almost any type of source or display to your CORIOview.

See our range of available input and output modules for your CORIOmaster at [help.tvone.com/r/docs/cm/modules/1](http://help.tvone.com/r/docs/cm/modules/1).

### Input modules

Module	Product number	Connections
Dual 4K 30 HDMI input module	CM-HDMI-4K-2IN	Supports up to 2 x 4K @30 Hz, or 1 x 4K @60 Hz HDMI compatible and HDCP 1.4 compliant
Quad HDMI input module		4 x HDMI up to 1920x1080 @60 HDMI compatible and HDCP 1.4 compliant
Dual DVI-U input module	CM-DVIU-2IN	2 x DVI-U HDCP 1.4 compliant, and HDMI compatible with an adapter
Quad HD/SD-SDI input module	CM-HSDSI-4IN	4 x HD/SD-SDI using BNC For co-axial cables
Dual HDBaseT input module Read more about the HDBaseT module on page 11.	CM-HDBT-2IN-1ETH	2 x HDBaseT For CATx cables HDCP 1.4 compliant Supports up to 2 x 4K @30 Hz, or 1 x 4K @60 Hz
Dual 3G-SDI input module	CM-3GSDI-2IN	2 x 3G/HD/SD-SDI using BNC For co-axial cables
Streaming media and 4K playback input module Read more about the Streaming media and 4K playback input module on page 10.	CM-AVIP-IN-1USB-1ETH CM-AVIP-IN-1USB-1ETH-128	1 x USB 3.0 1 x Ethernet Supports up to 2 x 4K @30 Hz, or 1 x 4K @60 Hz

## Output modules

Module	Product number	Connections
Dual 3G-SDI scaled output module	CM-3GSDI-SC-2OUT	2 x 3G/HD/SD-SDI using BNC, with scaling For co-axial cables
Single 4K30 scaling output module	CM-HDMI-4K-SC-1OUT	1 x HDMI up to 4K @30 Hz (UHD) HDCP 1.4 compliant
Dual DVI-I scaled output module	CM-DVI-I-SC-2OUT	2 x DVI-I HDCP 1.4 compliant
Dual DVI-U scaled output module	CM-DVI-U-SC-2OUT (Discontinued)	2 x DVI-U HDCP 1.4 compliant
Dual HDBaseT™ scaled output module Read more about the HDBaseT module on page 11.	CM-HDBT-SC-2OUT-1ETH	2 x HDBaseT For CATx cables HDCP 1.4 compliant
Quad HDMI scaled output module Read more about HDMI modules on page 12.	CM-HDMI-SC-4OUT	4 x HDMI up to 1080p @60 Hz HDCP 1.4 compliant
Dual HDMI keyed output module Read more about the HDMI keying module on page 20.	CM-HDMI-SC-2OUT-KEY	2 x HDMI up to 1080p @60 Hz HDCP 1.4 compliant
Dual 4K HDMI output module Read more about HDMI modules on page 12.	CM-HDMI-4K-SC-2OUT	2 x HDMI Supports up to 2 x 4K@30 Hz, or 1 x 4K@60 Hz clone-able to second port. HDCP 1.4 compliant

## Audio modules

Module	Product number	Connections
S/PDIF and analog audio module Not for CORIOmaster micro Read more about the S/PDIF and analog audio module on page 22.	CM-AUD-2IN-4OUT	Input: 1 x analog and 1 x S/PDIF Output: 1 x analog and 4 x S/PDIF

## Power supply module

Module	Product number	Connections
Redundant PSU for 4RU series units	CM-4RPS	1 x IEC power cord

## Adapters

You can use our adapters to connect any of the following formats to the DVI modules. Unless stated, you can use all of these adapters with both DVI-I and DVI-U modules.

<b>Adapter</b>	<b>Product number</b>	<b>Male connector</b>	<b>Female connector</b>
HDMI adapter	CMD1941	DVI	HDMI
Analog PC adapter	ZDH-2040	DVI	VGA
Analog RGBHV adapter	ZDB-2038	DVI	Analog RGBHV
YPbPr/YUV adapter	ZDR2042	DVI	YPbPr/YUV
YC (S-Video) adapter	ZDB2048	DVI-U only	2 x composite video
YC (S-Video) adapter	ZDS2046	DVI-U only	4-pin mini-DIN
Composite video adapter	ZDC-2050	DVI	BNC

## About your Streaming media and 4K playback input module

The Streaming media and 4K playback input module allows you to decode and play:

- Media and images from a USB drive
- Media and images from internal storage
- Video streams from IP sources.

Sources include streaming server, and any device used with an IP encoder, for example, the Magenta™ Encoder-100.

### Features

- Play two simultaneous channels of media, including IP streams
- Play video clips from USB drive up to 4K @30 Hz
- Play single IP streams up to 100 Mb/s
- Play dual IP streams up to 40 Mb/s
- Play still images up to 8K
- Play streams with low latency
- Play media from streaming server
- Create and save up to 20 playlists
- Primary channel supports up to 4K @30 Hz
- Secondary channel supports 1080p @60 Hz
- IP streams up to 4K @30 Hz
- Save up to 40 IP streams
- Full resolution and frame rate scaling
- Start playing media when your device starts
- Supports USB 3.0
- 8HD Player mode for synchronized playback of 8x 1080/30 fps files into 2x 4K @30 Hz inputs
- IP and Media playback labels
- FTP synchronization for media files
- Support AES CBC encrypted streams with 128 or 256 bit keys

For CORIOmaster™ and CORIOview™, CM-AVIP-IN-1USB-1ETH is available with 16 or 128 GB internal storage.



USB (LED) Indicates the status of the USB drive. Green ■ means that the USB drive is working correctly. Red ■ means that the USB drive is over current.

USB 3.0  
USB 2.0 Connect a USB drive to play media directly.  
For best results, we recommend using quality USB drives compatible with USB 3.0.

ST1 (LED) Indicates the status of the module. Green ■ means that the module is working correctly. Red ■ means that the module is starting, or that there is a problem.

ST2 (LED) Indicates the status of the sub-module. Green ■ means that the sub-module is working correctly. Red ■ means that the sub-module is starting, or that there is a problem.

LAN Connect an Ethernet cable to play media over IP.

If any status indicator stays red ■, restart your CORIOmaster™. If that doesn't work, contact tvONE support. Contact details are at the back of this guide.



## About your HDBaseT input and output module



The 4K HDBaseT™ modules allows you to receive uncompressed, high-resolution 4K video and audio from stand-alone transmitters located up to 150 m away. The input and output module also allows you to extend Ethernet to remote transmitters that support HDBaseT Class A and HDBaseT Class B.

See our range of active optical cables and signal extenders at [help.tvone.com/r/docs/g/signal-extension](http://help.tvone.com/r/docs/g/signal-extension)

### Features

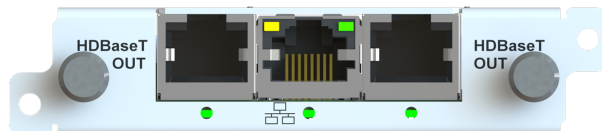
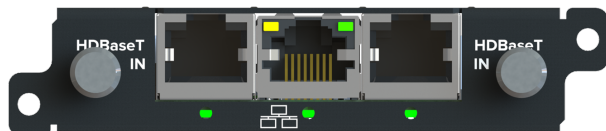
- HDBaseT Class A to 150 m
- HDBaseT Class B to 60 m
- 1x channel 4K60 or 2x channels 4K30 or below
- Audio support



**Status indicator**  means that the module is working correctly.  means that the module is starting, or that there is a problem.  means the module is powered down.



(LED)

**Ethernet links** Two LEDs built into the middle RJ45 connector.









(LED)

- Left LED Ethernet Link/Activity.
- Right LED Ethernet speed, off  for 10 Mbps or green  for 100 Mbps.

**HDBaseT link** Indicates the link status by the LED directly below the left and right RJ45 connectors.

(LED)

There is a green LED for the HDBaseT status and red LED for the HDMI status, they can combine to make orange.



LED status patterns	No Link	Ethernet Fallback	HDBaseT
No HDMI	 off	 fast green/off	 green
HDMI with HDCP	 red	 orange/off	 orange
HDMI without HDCP	 red/off	 orange/red/off	 orange/green

If any status indicator stays red , restart your CORIOmaster™. If that doesn't work, contact tvONE support. Contact details are at the back of this guide.

## About your HDMI input and output module

The High-Definition Multimedia Interface (HDMI™) modules are a proprietary audio/video interface for transmitting uncompressed video data and compressed or uncompressed digital audio data from an HDMI-compliant source device.

See our range of active optical cables and signal extenders at [help.tvone.com/r/docs/g/signal-extension](http://help.tvone.com/r/docs/g/signal-extension)

STATUS (LED) Indicates the status of this module. Green  means that the module is working correctly. Red  means that the module is starting, or that there is a problem. Off  means the module is powered down.

---

If any status indicator stays red , restart your CORIOmaster™. If that doesn't work, contact tvONE support. Contact details are at the back of this guide.

## 8HD Player – Synchronized playback mode

! The streaming media and 4K playback module has two different operating modes.

The 8HD player is designed to play up to 8x 1080p30 media files from the module's internal drive. Playback will occur in perfect synchronization into each of the four quadrants of a UHQ (4K) window and in this mode two of these windows are available to place on a canvas.

For example four files are shown with one 4K30 window. A media file has been cut in to 4x 1080p30 files.



In synchronized mode the windows placed on the canvas from the module are as shown. The window is separated in to four quadrants by dotted lines and the quadrants are numbered from 1 to 4 on the first window and from 5 to 8 on the second window.



### How to change the operating mode?

1. To change the operating mode in CORIOgrapher, select ⚙ Settings > Module Configuration
2. Find the Streaming media and 4K playback module that you want to set up, and select ... > Configure

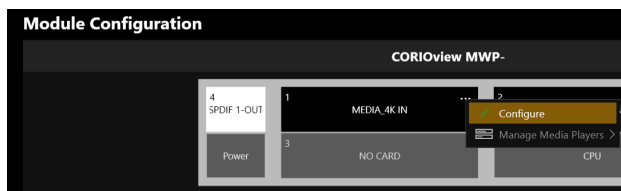

3. Change the operating mode from Standard to Synchronized.

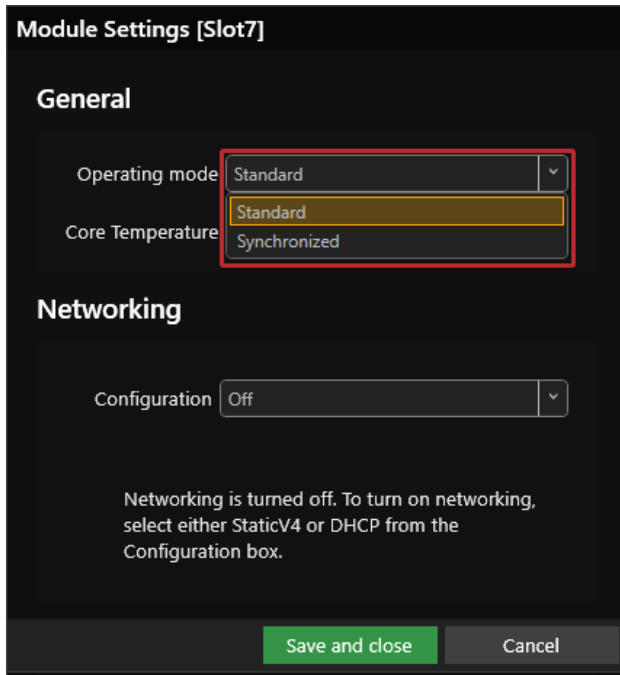

4. Select Save and close to change operating mode.
5. The Streaming media and 4K playback module will reboot into the synchronized mode.

## How do I setup and play my media?

To playback the files we must set up at least one synchronized group.

1. Double-click the window you wish to play media, and from Properties, select (Media Player) Manage.]

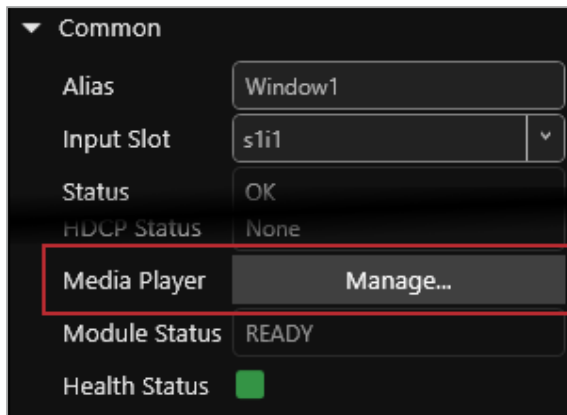

2. Select Synchronized Groups then + Add synchronized group

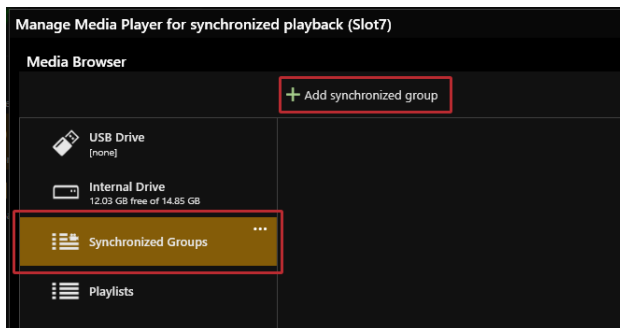

3. Give your group a name (must be unique and max of 64 characters)

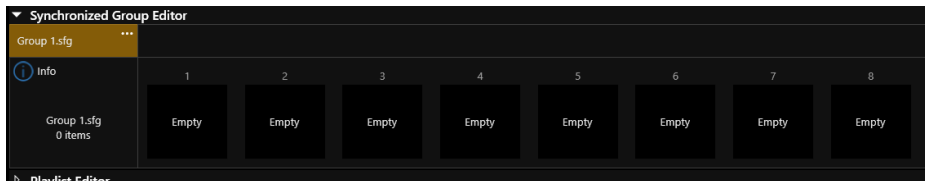
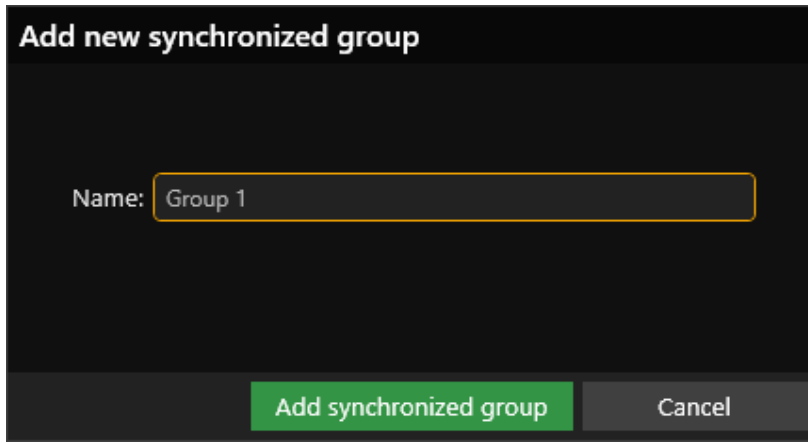

4. Drag and drop files from your Internal Drive to each empty slot (up to 8)

✔ The files can be in any order in the group, but they will playback into the quadrant for the number selected, for example a clip placed in position 8 will playback in the quadrant numbered 8.

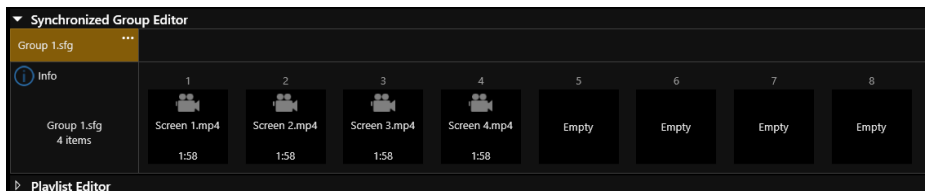

5. Synchronized groups can now be added to a playlist

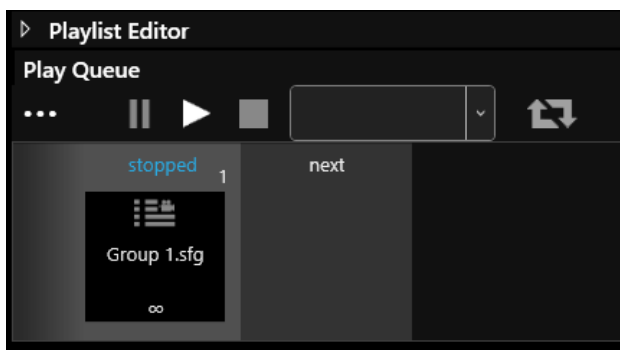
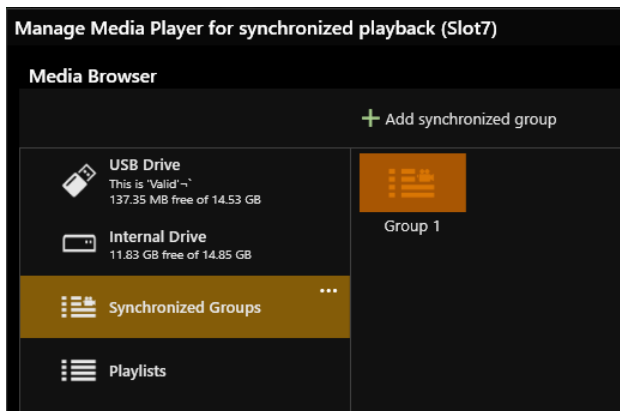

## Notes about playing media

- Media files should be the same resolution and frame rate
- Ideally, they should be from the same source, for example a video belt, but they can be different files.
- The longest file will determine playback time for the group and if there are shorter files the window will hold the last frame until the last file has finished playing before moving to the next synchronized group in the playlist or repeat if you have that option selected.
- The files should have the same presentation timestamps (PTS) to be frame synchronized for playback.
- Audio for the window is taken from the clip in position 1 only
- Only synchronized groups can be added to a playlist (not individual media files or stills)
- Synchronized groups can only be added to a play queue when the module is in synchronized mode.

## How to position displays and windows?

For example displays 1 through 4 must be physically placed under the correct window quadrant on the canvas for the content to playback into the correct display.



The displays must be positioned physically under the window content as the window cannot be split in to separate parts.

Four 1080p30 files can playback in to one 4K30 window.

The 8HD player can also be combined with keying to create exciting effects.

## FTP Server media synchronization

Media files can now be synchronized to your streaming media and 4K playback module over a network from an FTP server.

First set up your FTP server. The FTP server needs to be on the same network as your Streaming media and 4K playback module. Set up a user with a username and password.

Set up a shared folder for the user on your FTP server where you can put your contents. Your FTP settings must point the server to the shared folder.

Set up its credentials in CORIOgrapher™ by navigating to settings then network clients. Enter your FTP server IP address, port, username, and password.

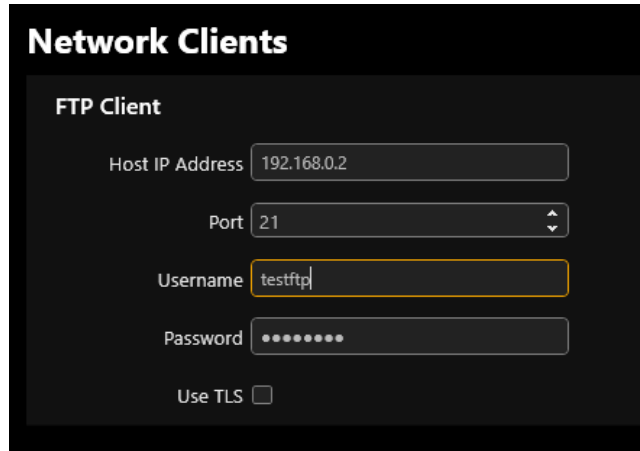

The screenshot shows the 'Network Clients' configuration interface. Under the 'FTP Client' section, there are four input fields: 'Host IP Address' with the value '192.168.0.2', 'Port' with a dropdown menu set to '21', 'Username' with the text 'testftp', and 'Password' with a masked field of seven dots. At the bottom, there is a checkbox labeled 'Use TLS' which is currently unchecked.

Connect your Streaming media and 4K playback module to the network and navigate to module configuration. Go to the module and click the ⋮ in the top right-hand corner then select Configure from the drop-down menu.

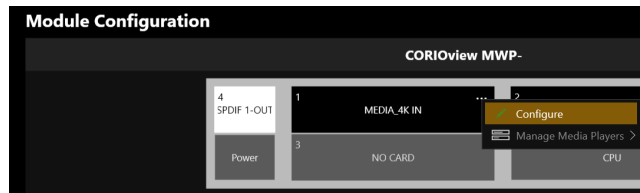

Go to Networking and select DHCP to obtain an IP address automatically or set up a static IP address. Save and close to confirm the settings.

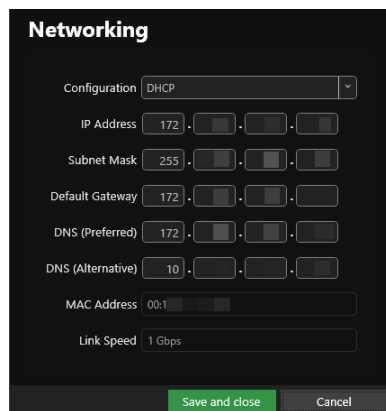

The screenshot shows the 'Networking' configuration screen. At the top, the 'Configuration' is set to 'DHCP'. Below this are several input fields for network parameters: 'IP Address' (172), 'Subnet Mask' (255), 'Default Gateway' (172), 'DNS (Preferred)' (172), and 'DNS (Alternative)' (10). There are also fields for 'MAC Address' (00:1) and 'Link Speed' (1 Gbps). At the bottom, there are two buttons: 'Save and close' (highlighted in green) and 'Cancel'.

To synchronize the shared FTP folder with the streaming media and playback module send the following API command using an external device or by using the console in CORIOgrapher.

**(Slot<N>.Storage.Local.StartFTPSync())**

<N> is the slot number where your media streaming and playback module is installed.

As an example where your streaming media module is in slot number 2 the following API command should be sent **Slot2.Storage.Local.StartFTPSync()**

If this was done for the first time a folder will be created in the root of the Internal Drive in the module called **ftpc**. Inside this folder two further ones will be created, **content** and **staging**. The FTP server will now synchronize with a folder on the module's internal drive. Files are first copied to the staging folder and once downloaded will be moved to the content folder.

All new files will be copied

Files with the same file name as already stored files will be copied if the file is different and will replace files on the Internal Drive in playlists the next point of playback. Files cannot be deleted on the module's internal drive by synchronization. This must be done manually.

It is important to note that the credentials for the FTP server are not set up per module but per CORIOmaster chassis. If you have more than one module in your chassis, they will need to synchronize with the same server and therefore will all receive the same files. Each module though will need to be synchronized separately as the API command is by slot number. Each module can select which files to play using playlists.



## AES file decryption

AES encrypted streams can be decrypted by the module. The streams must have been encoded using the AES CBC method and have 128 bit or 256 bit encryption keys. The streams must also be MPEG-TS streams.

Each stream needs an encryption mode key and an IV code. The encryption mode key is per stream and the IV is a 128 bit code that is for the whole system.

Select the type of stream encryption when adding the new IP stream

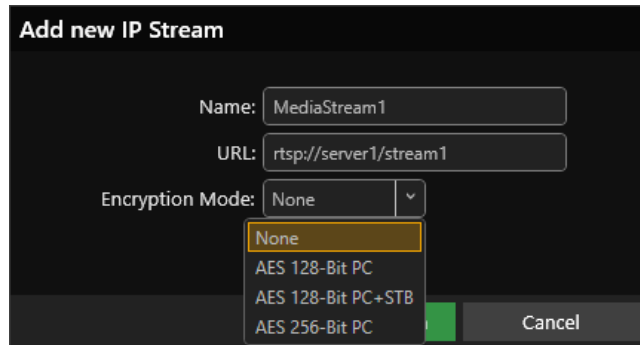

**Add new IP Stream**

Name:

URL:

Encryption Mode:  ▼

- None
- AES 128-Bit PC
- AES 128-Bit PC+STB
- AES 256-Bit PC

Add the HEX encryption key for the stream into the stream properties box. The key will be provided by the stream provider.

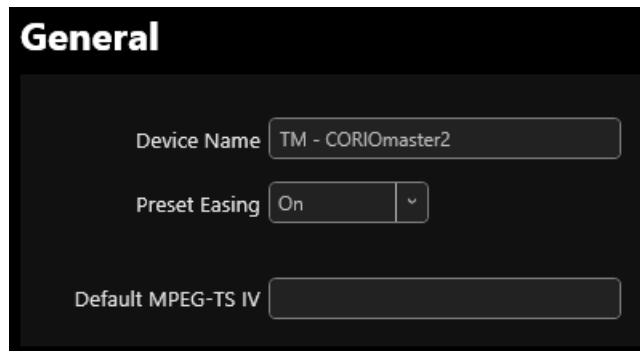

**General**

Device Name

Preset Easing  ▼

Default MPEG-TS IV

Enter the Default MPEG-TS IV into the General area in settings. The IV must be set as this is used for every item in the queue and the user cannot edit this value per stream.



If you need help to set up AES then contact your distributor, or tvONE support.

## About your dual output keying module

There are two HDMI 1080p60 outputs per module for keying. Multiple modules can be installed per system with the number depending upon which CORIOmaster chassis you have.

Dual output keying module CM-HDMI-SC-2OUT-KEY

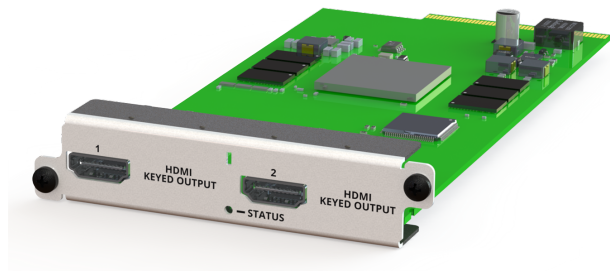

The module uses a luminance keyer. Each output has two layers, a background layer, and a foreground/keying layer. Video in the foreground layer can be keyed through from the background layer in real time with no additional latency.

Add a display from a keying module on to a canvas. Add background windows as normal. Add foreground windows to the keying layer by clicking on them to bring up the properties panel for the window then scroll down to Keying and enable by selecting the tick box. The window will now be placed into the keying layer and a keying symbol will appear in the top right-hand side of the window to indicate that this window will be keyed.

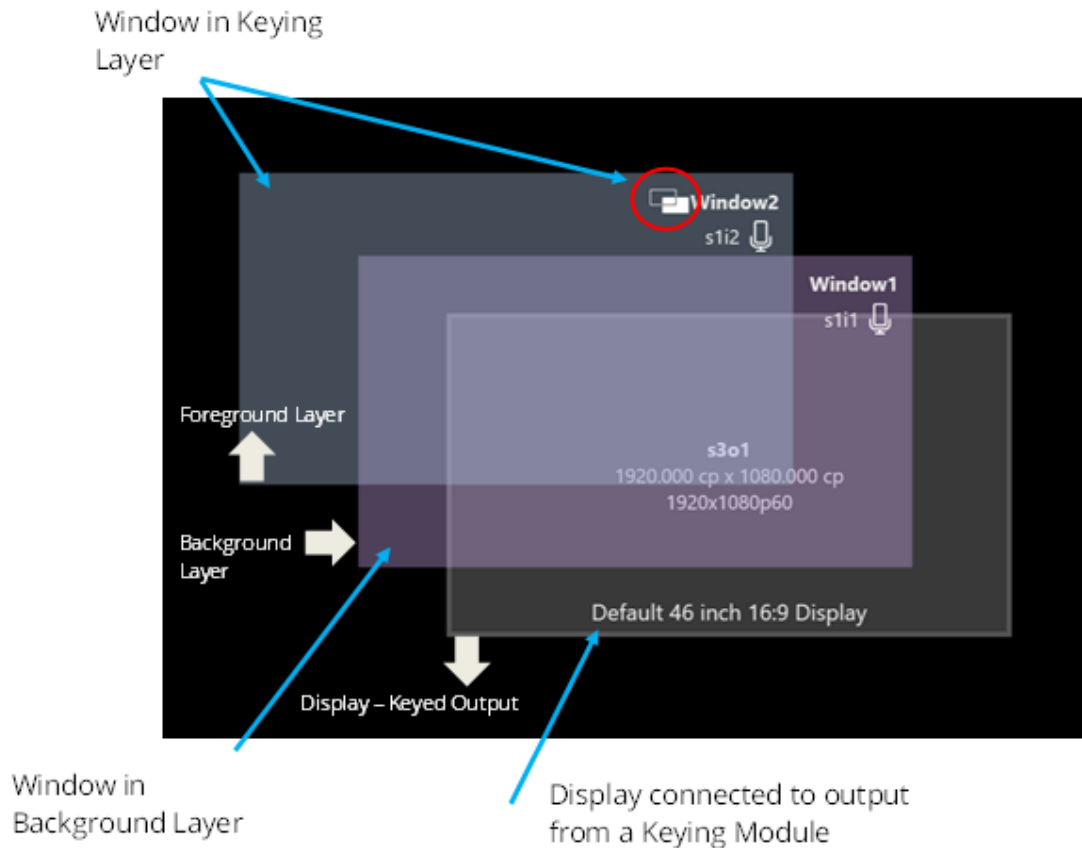

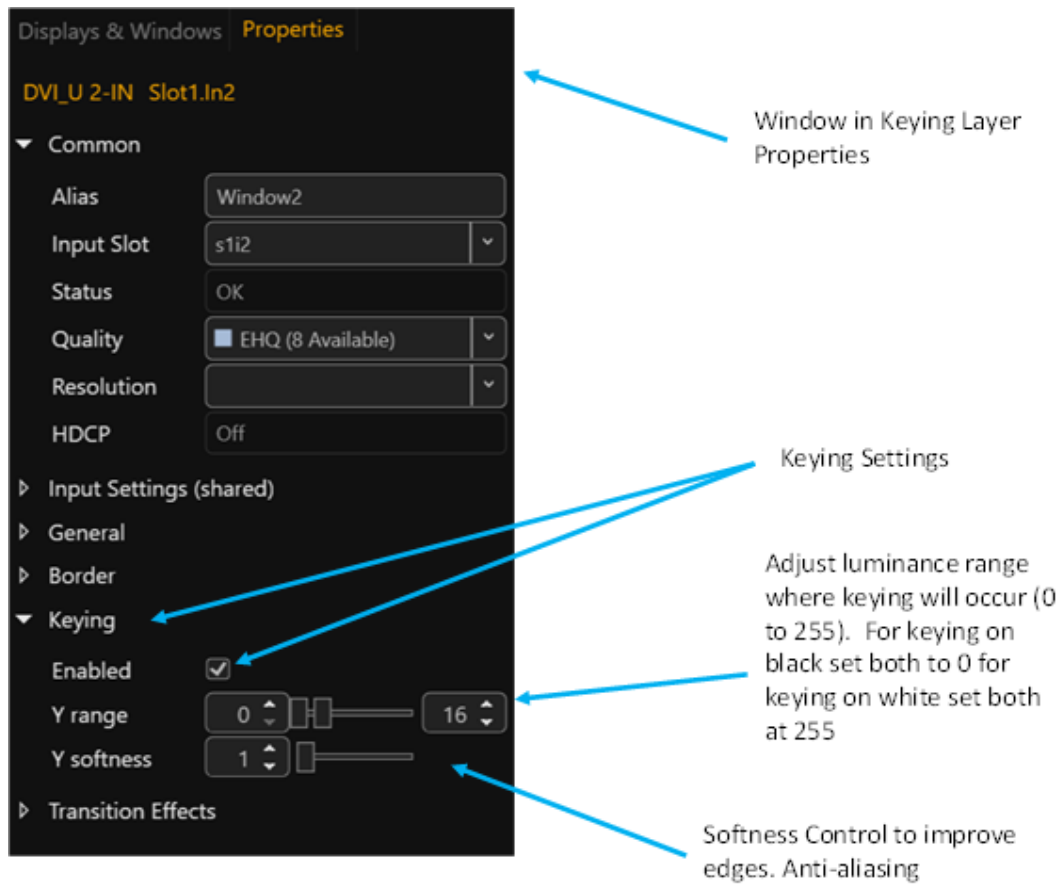

There are two adjustments you can make using slider controls.

One is for the keying range. This sets the upper and lower brightness levels where keying will occur. For example if both settings are set to 0 then keying will occur in the black areas of the foreground layer and if both are set to 255 then keying will occur in the white areas of the foreground window. Set these controls to suit your video signal.

There is also a softness control which has an anti-aliasing effect on the edges where keying has occurred.

## About your S/PDIF and analog audio module

You can use 3.5 mm terminal block connectors to connect to a range of audio inputs and outputs.

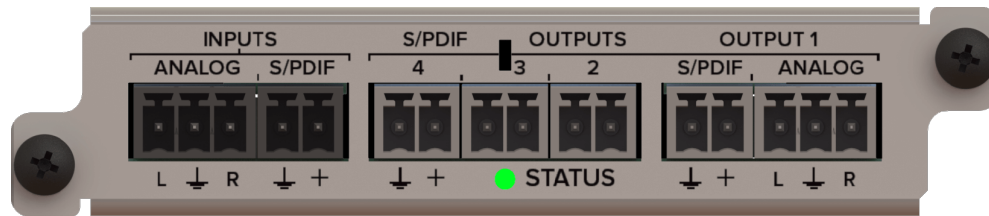

INPUTS, ANALOG	Connect an analog audio device.
INPUTS, S/PDIF	Connect a digital audio device.
OUTPUT 1 S/PDIF ANALOG	Connect an analog or digital device to play audio from the video installation on canvas 1.
OUTPUT 2	S/PDIF output. Connect a digital device to play audio from the video installation on canvas 2.
OUTPUT 3	S/PDIF output. Connect a digital device to play audio from the video installation on canvas 3.
OUTPUT 4	S/PDIF output. Connect a digital device to play audio from the video installation on canvas 4.
STATUS (LED)	Indicates the status of the module. Green means that the module is working correctly. Red means that there is a problem.

If any status indicator stays red, restart your CORIOmaster. If that doesn't work, contact tvONE support. Contact details are at the back of this guide.

### Compatibility

Your S/PDIF and analog audio module is compatible with your CORIOmaster, or CORIOmaster mini.

If you have a CORIOmaster micro, you cannot have an S/PDIF and analog audio module, but you can use the independent S/PDIF audio output.

### Supported formats

The S/PDIF and analog audio module supports all audio formats outputted as PCM with a frequency of 48 kHz.

### Inputs

Your S/PDIF and analog audio module has two inputs, one analog and one digital input.

You can use inputs from the S/PDIF and analog audio module as breakaway audio only.

#### What's breakaway audio?

Breakaway audio is independent of the windows on your video wall. It doesn't change when the sources playing in your windows change. The audio is sent to all enabled outputs.

### Outputs

Your S/PDIF and analog audio module has four outputs. Each output is locked to a canvas in the Editor. Output 1 is locked to canvas 1, output 2 is locked to canvas 2, and so on.

Output 1 has one analog and one S/PDIF digital port. You can send the same output to both ports, but you cannot send a different output to each port. Because output 1 is locked to canvas 1, only canvas 1 is capable of sending both analog and digital audio.

To choose a canvas, select a canvas number from Canvas.



Outputs 2-4 each have one digital S/PDIF output.

## Hardware recommendations

At tvONE, we design our products to the highest quality standards. To get the best results from our products, we recommend that you use the best quality connectors, cables, and adapters. Consider the points below when you choose accessories and position equipment.

- For best results at resolutions of 1080p60 or below with HDMI or DVI, use cables under 15 m long, or shorter if you use connection adapters. If you need to place your products more than 15 m apart, use active optical cables or a signal extender.  
For best results at resolutions of 4K60 or higher with HDMI, use cables under 2-3 m, or shorter if you use connection adapters. If you need to place your products more than 3 m apart, use active optical cables or a signal extender.  
See our range of active optical cables and signal extenders at [help.tvone.com/r/docs/g/signal-extension](http://help.tvone.com/r/docs/g/signal-extension).
- For best results with HDMI, use High Speed, Premium High Speed, or Ultra High Speed HDMI cables.
- For best results with DisplayPort, use certified cables under 2 m long.
- In industrial environments, use shielded Ethernet cables.  
Shielded Ethernet cables are often marked F/UTP, FTP, or STP. Use shielded Cat 6 or above cables with HDBaseT input and output modules and Streaming media and 4K playback input modules.
- Use good quality USB 3.0 drives.
- For more hardware recommendations for your product, see the specification sheet.

Read more about HDMI at [hdmi.org](http://hdmi.org).

Read more about DisplayPort at [displayport.org](http://displayport.org).

## Get help with your Magenta Encoder-100

The Magenta Encoder-100 works with your CORIOmaster™ product.

Read about configuring your Magenta Encoder-100 at [help.tvone.com/r/docs/cm/encoder-100/1](http://help.tvone.com/r/docs/cm/encoder-100/1).

## Set it up

This section contains everything you need to know about installing and setting up your video wall with CORIOmaster™ and CORIOgrapher™.

### In this section

Planning and installing video installations .....	25
Planning a video installation .....	25
Installing your hardware .....	26
Setting up a video installation in CORIOgrapher™ .....	29
CORIOgrapher™ system requirements .....	29
About CORIOgrapher™ .....	30
Getting started with CORIOgrapher™ .....	31
Naming input and output ports and channels .....	33
Enabling secure mode .....	34
About HDCP .....	35
Creating a video installation .....	39
Testing your video installation .....	42
Set up and test audio .....	43
Settings .....	46
Device settings .....	47
Naming your CORIOmaster™ .....	47
Resetting your CORIOmaster™ to factory default settings .....	47
Choosing your working units .....	48
Backing up and restoring your settings .....	48
Resetting your CORIOmaster™ to factory default settings .....	50
CORIOmaster micro™ settings .....	51
Configuring the buttons of your CORIOmaster micro™ .....	51
User settings .....	52
Creating and editing users .....	52
Changing other users' passwords .....	53
Changing your own password .....	54
Network settings .....	54
Configuring network settings for your CORIOmaster™ .....	54
Configuring network settings for streaming media .....	56
Playlist settings .....	58
Renaming playlists and moving playlists between modules .....	58
Deleting playlists .....	58
Encoders and streams settings .....	59
Managing encoders and streams .....	59
Resolution Editor .....	61
About custom resolutions .....	61
Creating and editing custom resolutions .....	61

# Planning and installing video installations

The first step towards creating a video installation with your CORIOmaster™, CORIOmaster mini™, or CORIOmaster micro™ is planning and setting up your hardware.

## In this section

Planning a video installation .....	25
Installing your hardware .....	26

## Planning a video installation

It's really helpful to write a plan before you start installing. A plan saves you time and effort later, and helps you make sure you have all the equipment you need.

Download the printable plan from [help.tvone.com/r/docs/cm/home/1](http://help.tvone.com/r/docs/cm/home/1)

If you can't print and fill out the plan, think about the following questions:

### Overall effect

- What do you want your video wall to look like?
- How large is your video wall?
- What do you want to accomplish?

### Displays

 **Video tearing**  
Using a mixture of frame rates and/or resolutions can cause video tearing. For best results, make sure all your displays use the same frame rate.

- How many displays do you need?
- What sizes are the displays?
- What are the bezel sizes of the displays?
- What is the native resolution of each display?
- Do you need displays that support HDCP (High-bandwidth Digital Content Protection)?
- How many projectors do you need?
  - Do you need to blend the edges of displays?
  - How much overlap do you need?

### Sources or inputs

- What types of source do you need?
- What is the native resolution of each source?
- What is the frame rate of each source?
- Will the sources be available at all times that the video wall is operating?
- Is there any switching or processing before the source reaches your CORIOmaster™?

### Windows

- How many windows do you need to create the effect you want?  
Include all windows, even those that are not active all the time.
- What level of quality do you need for each window?  
In some cases, you can't have the highest quality for all your windows. Which windows can be lower quality?

#### What is a window?

A window is a container for a source input. You can have multiple windows playing the same source. You can resize, move, and rotate windows in the video wall editor.

### Presets

- Do you want to use presets in your video wall?
- What type of control system will you use to operate the video wall and change between presets?

#### What is a preset?

A preset stores information about windows, including positions, transitions, and effects such as borders or rotation. You can save presets and recall them later from the dashboard, or using the buttons of your CORIOmaster micro.

## Installing your hardware

Once you have planned and collected your hardware, you can set it up. First install your displays and place your sources. Then connect your displays to your output modules and your sources to your input modules.

### Who can do this?

Anyone can do this task, but we recommend that you consult a qualified AV installer.

### Placing your CORIOmaster™ and displays

When you decide where to place your hardware, consider these points:

- Availability of electrical outlets
  - Distance from CORIOmaster to sources and displays
    - For best results at resolutions of 1080p60 or below with HDMI or DVI, use cables under 15 m long, or shorter if you use connection adapters. If you need to place your products more than 15 m apart, use active optical cables or a signal extender.
    - For best results at resolutions of 4K60 or higher with HDMI, use cables under 2-3 m, or shorter if you use connection adapters. If you need to place your products more than 3 m apart, use active optical cables or a signal extender.
- Read about our adapters on page 9.
- See our range of active optical cables and signal extenders at [help.tvone.com/r/docs/g/signal-extension](http://help.tvone.com/r/docs/g/signal-extension).
- Make sure your devices are within the operating specification.
  - Installation environment
    - In industrial environments, use shielded Ethernet cables.



## Position your displays and sources

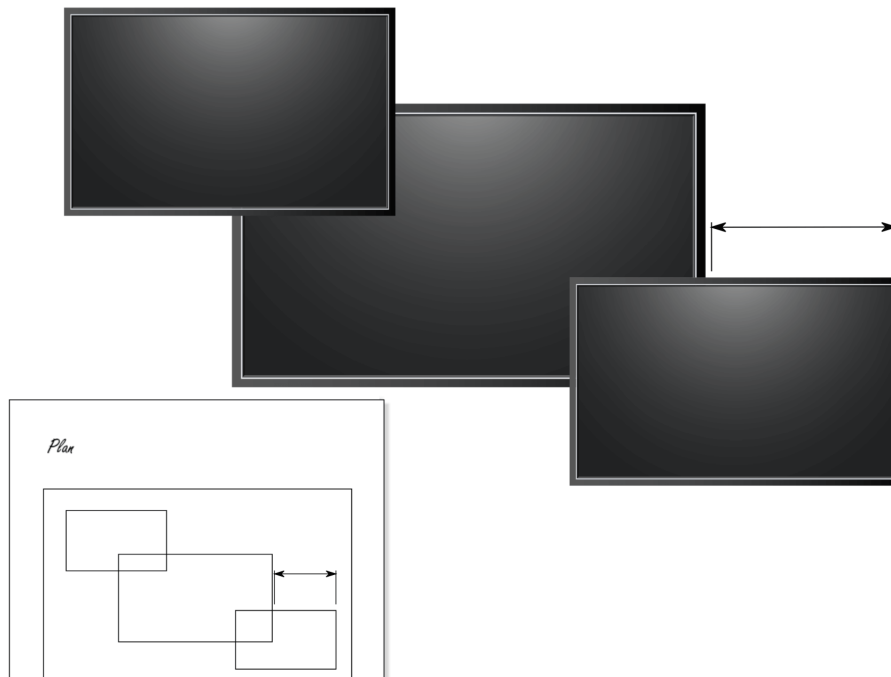

1. Use your plan to help you position your displays, which can be screens and/or projectors. Make sure you note all the measurements, so you can make an accurate video wall in CORIOgrapher™.
2. Position your sources. Follow the advice above when you choose where to put your sources.
3. Connect your displays or projectors to the output modules of your CORIOmaster.



**!** It is recommended to use a cable mount to reduce the stress on the connector caused by heavy cables. See the installation instructions that came with your module or device.

**✓** Keep a note of which display is connected to which port. You can use this information later when you name inputs and outputs in CORIOgrapher. You can also label the inputs and outputs directly.

4. Connect your sources to the input modules of your CORIOmaster.



Keep a note of which source is connected to which port. You can use this information later when you name inputs and outputs in CORIOgrapher.

5. Connect your CORIOmaster to your network. If you want to control your CORIOmaster with a serial controller, connect a serial controller.



6. Connect your CORIOmaster to an electrical outlet and power on.



Optional redundant PSU requires connection to a separate electrical outlet.



You can now create your video wall in CORIOgrapher.

## Setting up a video installation in CORIOgrapher™

When you've finished installing your hardware and connected everything to your CORIOmaster™, you can create your video installation in CORIOgrapher.

### In this section

CORIOgrapher™ system requirements .....	29
About CORIOgrapher™ .....	30
Getting started with CORIOgrapher™ .....	31
Naming input and output ports and channels .....	33
Enabling secure mode .....	34
About HDCP .....	35
Creating a video installation .....	39
Testing your video installation .....	42
Set up and test audio .....	43

### Creating and testing your first video installation

Learn how to create and test a basic video installation.

- Creating a basic video installation
- Testing your video installation

## CORIOgrapher™ system requirements

CORIOgrapher:













- Works with PCs running Windows® 10 and 11
- Does not work with touch-screen-only devices, including tablets or phones
- Works with Microsoft Surface Pros and similar touch screen devices  
Full support for touch screen devices is under development
- Installs Windows .NET 4.6, if you don't have it
- Needs 600 MB of disk space during installation
- Is approximately 60 MB in size once installed

To use the preview feature, your PC must have Windows Media Player installed, and it must have been launched at least once. Preview performance depends on the specifications of your PC and number of windows in your installation.

# About CORIOgrapher™

CORIOgrapher is the software that controls your CORIOmaster™. You can create up to four video installations, with multiple screens and windows, and add transitions and effects for a state-of-the-art dynamic video wall experience.

## CORIOgrapher main areas

 Home	 Home	Home is where you connect to a device, load a configuration from a file, or create an offline configuration.
 Editor	 Editor	<b>CORIOmaster and CORIOmaster2 only.</b> Editor is where you create your installations on each canvas. <ul style="list-style-type: none"><li>▪ If you have a CORIOmaster or CORIOmaster mini, you can create up to four canvases.</li><li>▪ If you have a CORIOmaster micro, you can create up to two canvases.</li><li>▪ If you have a CORIOmaster2, you can create up to three canvases.</li></ul>
 Dashboard	 Dashboard	Dashboard is where you control the actions of your canvases.
 Standby	 Standby	<b>CORIOview and CORIOmaster micro only.</b> Standby puts your device into standby mode.
 Help	 Help	Help opens tvONE help for your product.
 Settings	 Settings	Settings is where you configure your system, network, modules, and more.

# Getting started with CORIOgrapher™

When you first open CORIOgrapher, you see  Home.

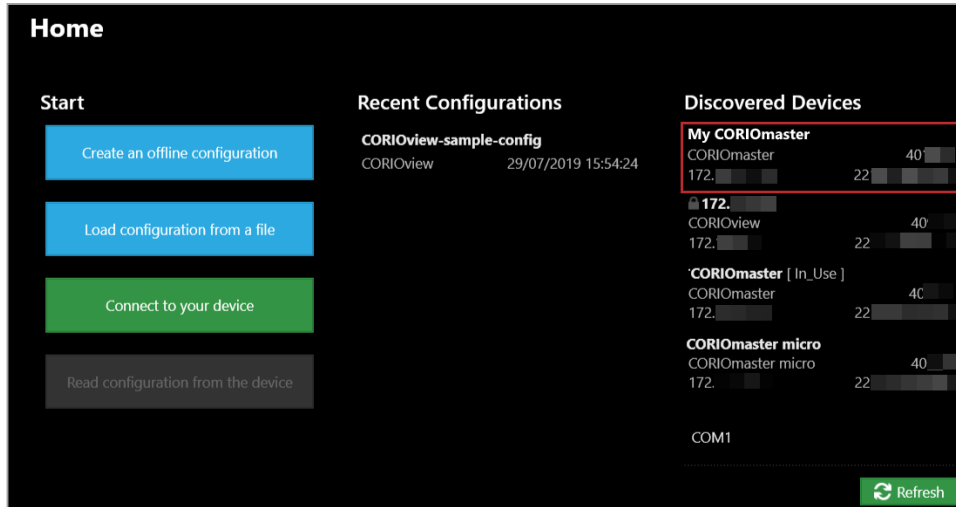

- If you've already set up your hardware, you can connect to your CORIOmaster™, CORIOmaster mini™, or CORIOmaster micro™ and get information about its configuration of modules.
- If you haven't set up your hardware yet, you can create a configuration offline. Or, you can load a configuration from a file, if you have one. You can save your configuration, and send the configuration to your CORIOmaster later. You can also use saved configurations to configure other CORIOmaster units.

Read about setting up hardware on page 26.

## To connect to your CORIOmaster and get its configuration

The easiest way to get started using CORIOgrapher is to get the configuration of inputs and outputs directly from your CORIOmaster.

1. From  Home, select your CORIOmaster from Discovered Devices.

If your CORIOmaster isn't in the list, select Refresh.

If you can't see your CORIOmaster, read troubleshooting advice on page 130.

2. Enter your administrator login details.

When you first log in as an administrator, enter the username `admin` and password `adminpw`. Leave the Secure option clear.

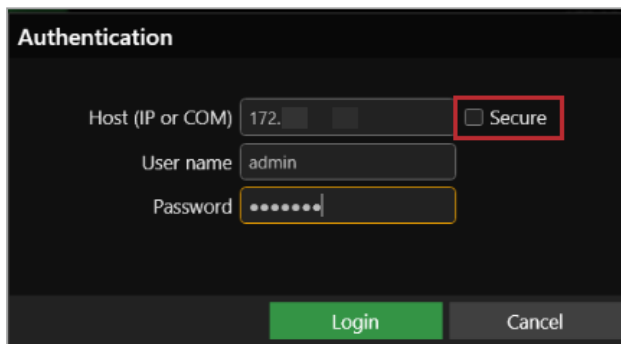



If Host (IP or COM) doesn't contain an IP address, read troubleshooting advice on page 130.

3. When you are logged in to your CORIOmaster, select Read to get its configuration.

## To log in with secure mode

You can communicate securely with your CORIOmaster. To use secure mode, enable secure mode.

Read about enabling secure mode on page 34.

When secure mode is active, in  Home you can see  next to the name of the CORIOmaster.

## To create a configuration offline

You don't need to be connected to a CORIOmaster to create video installations, but you do need to recreate the configuration of your CORIOmaster so that you're using the correct inputs, outputs, and devices.

You can also create offline configurations to help you decide what hardware you need.

1. From  Home, select Create an offline configuration.
2. In Configuration Editor, choose a device, and give your configuration a name.
3. For each slot, choose a module from the list.

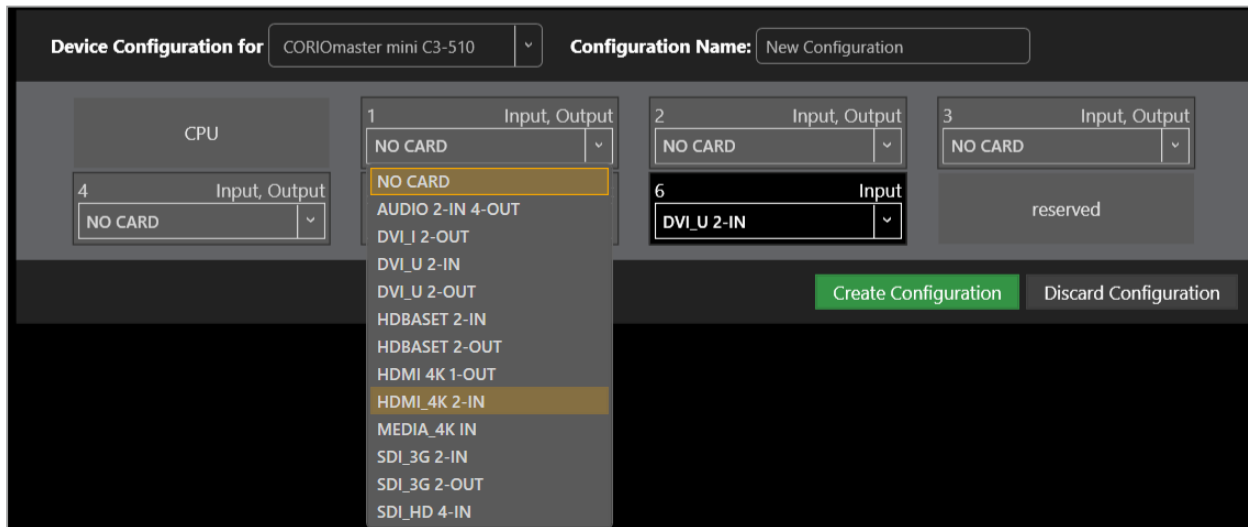



- The number of slots available depends on your device.
- You don't have to use all the slots.
- If you are creating a configuration for an existing CORIOmaster, match your configuration to the modules of your CORIOmaster.
- If you are creating a configuration to help you decide what modules you need, there are some guidelines on where to put your modules.

Read about the configuration of a CORIOmaster on page 2.

Read about the configuration of a CORIOmaster mini on page 4.

## To send a configuration to your CORIOmaster

You can send a configuration to your CORIOmaster from  Home. You can either create a configuration offline, or load a saved configuration.

1. Create or load a configuration.
2. In  Home, select your device from Discovered Devices and enter your administrator login details.  
The default username is `admin` and the default password is `adminpw`.
3. Select Send.

# Naming input and output ports and channels

You can name the input and output ports and channels for each slot in CORIOgrapher™.

## Why should I name input and output ports and channels?

CORIOgrapher uses aliases to give each input or output port or channel in each slot a unique name. For example, the first port in slot 1 is named s1i1 for slot 1 input 1. These unique identifiers tell you the position, but not what is connected to that input or output.

Name your ports and channels with something that indicates what is connected to the port, or playing on the channel. Doing this can help you identify what is what in your configuration, and makes it easier for you to see quickly which source is playing in which window. For example, you might rename s1i1 to Camera 1.

### Naming the channels of a Streaming media and 4K playback input module

The Streaming media and 4K playback input module has two channels. Each channel refers to a play queue, not to a specific streaming source. If you intend to build play queues with multiple sources, for example, one or two streaming sources and media items from a USB drive, then consider unique names such as PlayQueue1 and PlayQueue2. If you intend to always have just one streaming source in a play queue, then you could use names like WOWZastream, or LectureTheatreStream.

## Naming rules

Names must be unique and start with a letter. They can contain letters, numbers, and underscores, and can be up to 21 characters long.

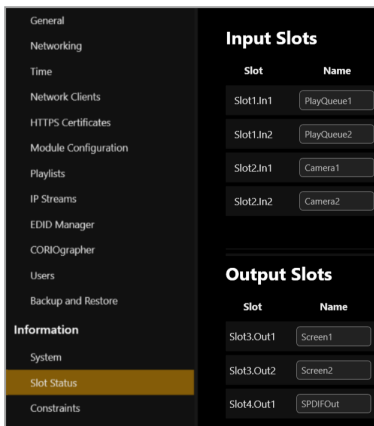

## To name input and output ports

1. In CORIOgrapher, select  Settings > Slot Status.
2. For each port, enter a useful name.

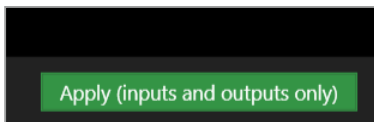

3. To save your new names, select Apply (inputs and outputs only).



If you are creating an offline configuration, select  Editor >  Save to file.

## Enabling secure mode

If you have a CORIOmaster™ or CPU module purchased from 2019 onwards, you can use secure mode to encrypt information you send and receive from your CORIOmaster.

### About secure mode

Secure mode uses HTTPS to encrypt all communication between CORIOgrapher™, or another secure controller, and your CORIOmaster. HTTPS encryption uses TCP port 443.

Secure mode only works on CORIOmaster units with a real time clock installed in the CPU module.

When secure mode is active, in  Home you can see  next to the name of the CORIOmaster.





Secure mode disables unsecured connections over Ethernet. Unencrypted third-party controllers do not work over Ethernet when you use secure mode. You can still use unsecured controllers that are connected directly to your CORIOmaster, using the serial port of the CPU module.

Read troubleshooting advice on page 133.

### Enabling secure mode

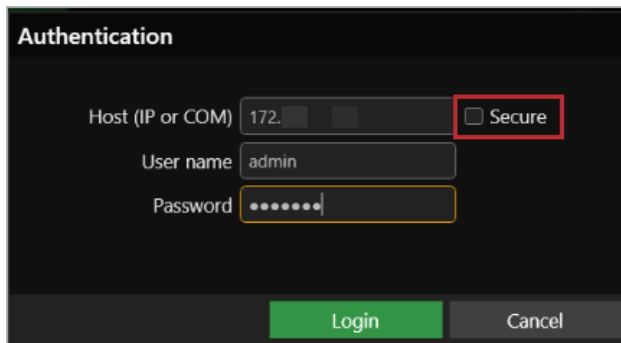
1. Clear the Secure option and log in to CORIOgrapher.



2. Select  Settings > Networking.
3. Select Secure connection.

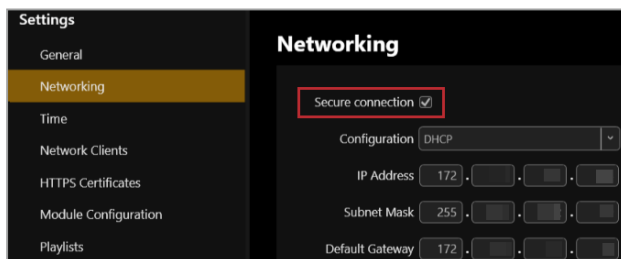

4. Select Save > Yes. CORIOmaster restarts.
5. Select Secure and log in.

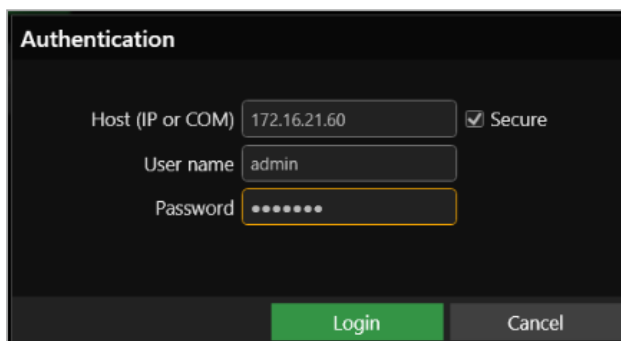



# About HDCP

## What is HDCP?

High-bandwidth Digital Content Protection (HDCP) is a form of digital copy protection developed to prevent copying of digital audio and video content as it is sent between devices, for example protecting the content as it travels from a Blu-ray player to an amplifier to your TV.

## What support does my CORIOmaster™ have for HDCP?

Your CORIOmaster can support video inputs and displays with no HDCP or with HDCP version 1.4 when using supported modules.

Read about modules on page 7.

## How does my CORIOmaster handle mixing of HDCP versions?

CORIOmaster uses the inputs that are active on a canvas to determine the HDCP requirements for your displays. Depending on the displays you have connected to your CORIOmaster, you may find that some displays are blanked. This is because the required HDCP level is not supported for those displays that is required by the input sources, for example a blu-ray player.

Below are some of the possible source and display combinations and how different source encryption levels affect your displays.

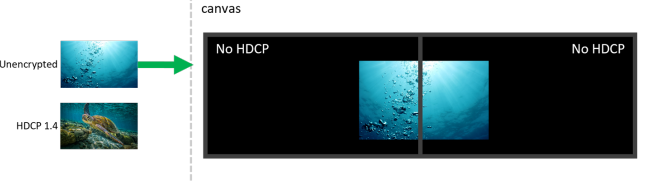
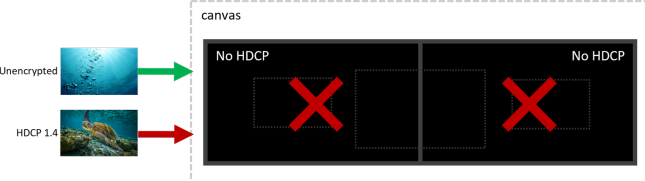
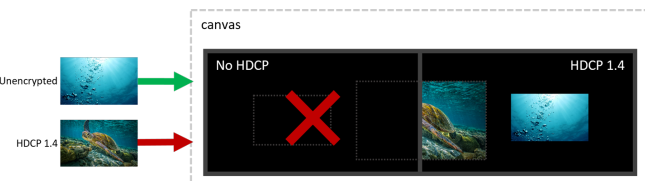
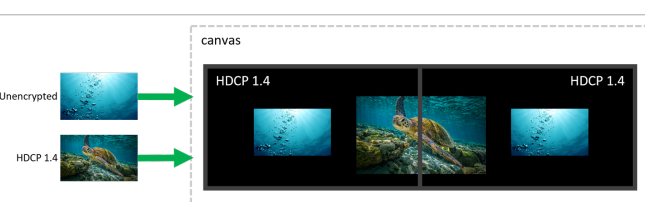
	<p><b>Unencrypted displays</b></p> <ul style="list-style-type: none"><li>✓ You can show unencrypted video on any displays as there are no restrictions.</li></ul>
	<p><b>Unencrypted displays with HDCP encrypted sources</b></p> <ul style="list-style-type: none"><li>✗ Any unencrypted displays will be blanked as you are not allowed to show encrypted sources on unencrypted displays.</li></ul>
	<p><b>Unencrypted displays and HDCP 1.4 displays</b></p> <ul style="list-style-type: none"><li>✓ HDCP 1.4 displays can show unencrypted, HDCP 1.4 encrypted sources.</li><li>✗ Any unencrypted displays will be blanked as you are not allowed to show encrypted sources on unencrypted displays.</li></ul>
	<p><b>HDCP 1.4 displays</b></p> <ul style="list-style-type: none"><li>✓ You can show unencrypted, and HDCP 1.4 video on HDCP 1.4 displays.</li></ul>

## How do I change the HDCP version of an input?

Your CORIOmaster's inputs negotiate with each connected source which version of HDCP to use, and the source will then make decisions on how to present the content, which may be no video.

You can choose to disable HDCP support. This may help to avoid unneeded negotiation.

**!** Changing the HDCP properties for an input may affect all canvases that input is used on, for example if the displays have different HDCP support they may be blanked.

### ■ Bulk updating the input HDCP properties

1. In CORIOgrapher, select  Settings > Slot Status.
2. When connected to your device the HDCP Status will automatically update to show the version negotiated with the source.

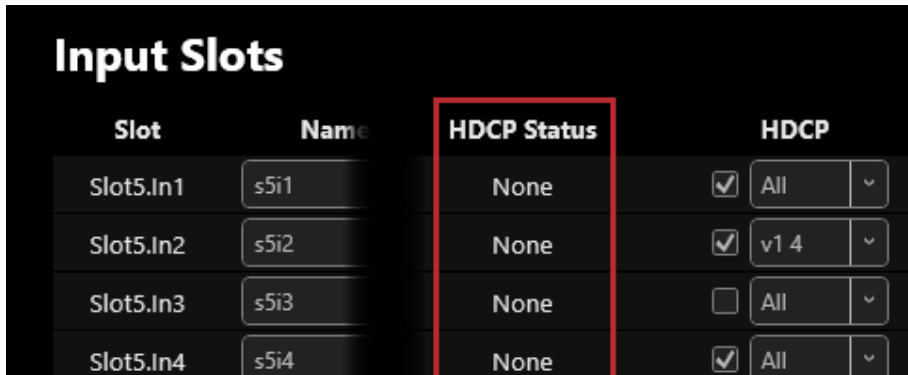

Slot	Name	HDCP Status		HDCP
Slot5.In1	s5i1	None	<input checked="" type="checkbox"/>	All
Slot5.In2	s5i2	None	<input checked="" type="checkbox"/>	v1 4
Slot5.In3	s5i3	None	<input type="checkbox"/>	All
Slot5.In4	s5i4	None	<input checked="" type="checkbox"/>	All

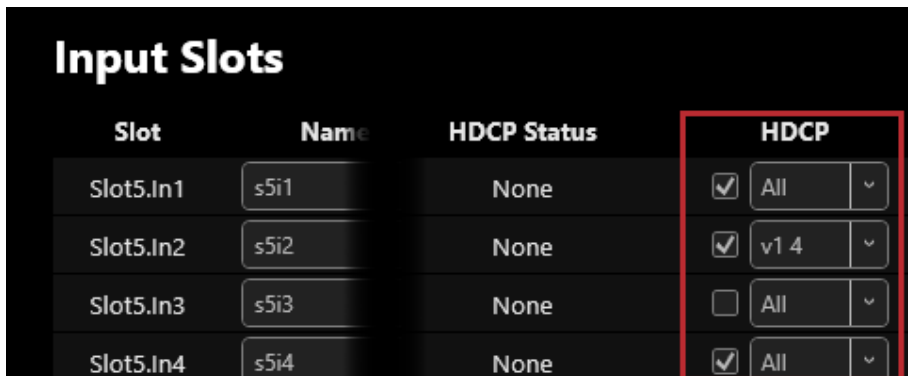

3. For each port, select if HDCP is enabled and if available which HDCP version to negotiate with the source.

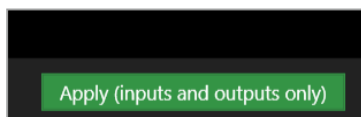

Slot	Name	HDCP Status		HDCP
Slot5.In1	s5i1	None	<input checked="" type="checkbox"/>	All
Slot5.In2	s5i2	None	<input checked="" type="checkbox"/>	v1 4
Slot5.In3	s5i3	None	<input type="checkbox"/>	All
Slot5.In4	s5i4	None	<input checked="" type="checkbox"/>	All

4. To save your changes, select Apply (inputs and outputs only).



5. If you are creating an offline configuration, select  Editor >  Save to file.

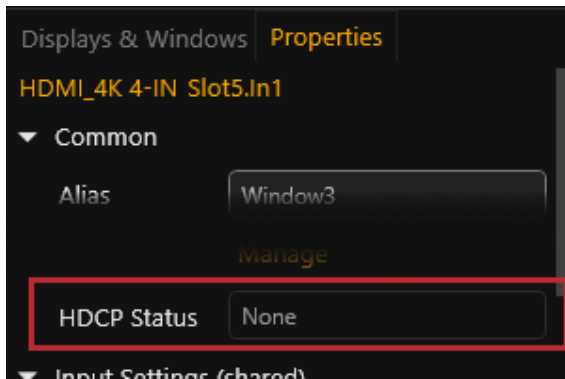

- **Individually from each window**

1. In CORIOgrapher, select  Editor, double-click the window to open Properties,
2. When connected to your device the HDCP Status will automatically update to show the version negotiated with the source.

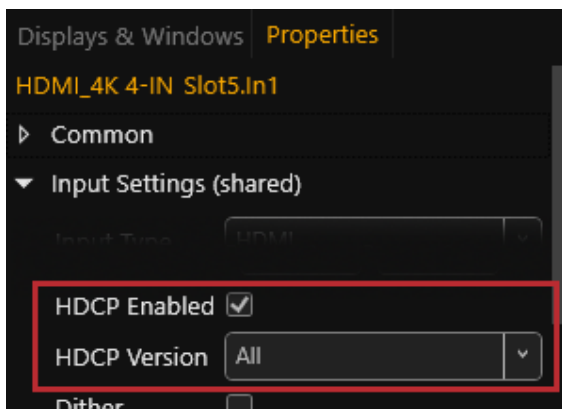

3. If you do not require HDCP you can disable it by clearing the HDCP Enabled option, or if available, select the HDCP Version which will force the input to try to negotiate that version with the source.



4. When you are happy, select  Take and then  Set device startup to save the take on your CORIOmaster, so your changes will be restored on start up.
5. If you are creating an offline configuration, select  Save to file.

## How do I change the HDCP support of an output?

Your CORIOmaster's outputs negotiate with each connected display which version of HDCP to use.

 You are not allowed to output HDCP encrypted content on unencrypted or lower HDCP version displays.

- **Bulk updating the output HDCP properties**

1. In CORIOgrapher, select  Settings > Slot Status.
2. When connected to your device HDCP Status will automatically update to show if HDCP is active.

The screenshot shows the 'Output Slots' table. The 'HDCP Status' column is highlighted with a red box. The table shows the following data:

Slot	№	HDCP Status	HDCP
Slot3.Out1	s3o1	Off	HoldOn
Slot3.Out2	s3o2	Off	KeepOff

- For each port, select the HDCP mode to tell the output how to handle the display.

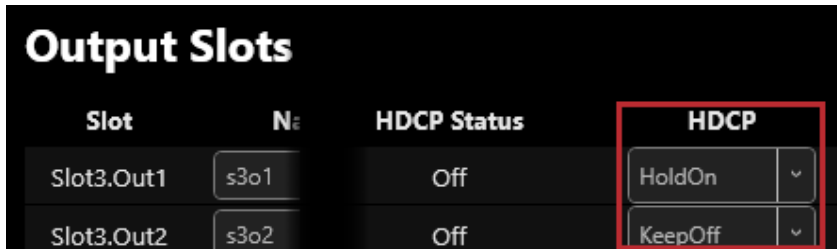

- HoldOn: Keeps HDCP active
- KeepOff : Turns off HDCP
- FollowSourcesTurns HDCP on or off depending on the source

- To save your changes, select Apply (inputs and outputs only).

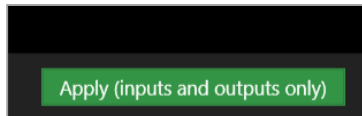

- If you are creating an offline configuration, select Editor > Save to file.

▪ **Individually from each display**

- In CORIOgrapher, select Editor, double-click the display to open Properties,
- When connected to your device HDCP Status will automatically update to show if HDCP is active.

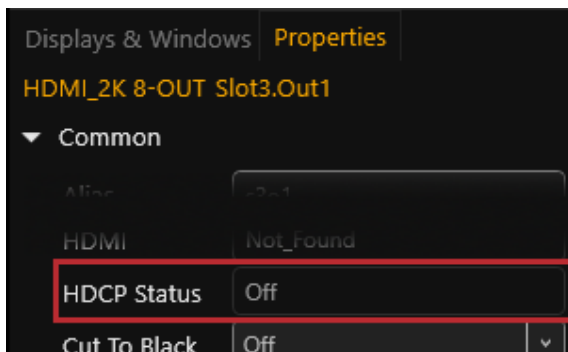

- Select the HDCP Mode to tell the output how to handle the display.

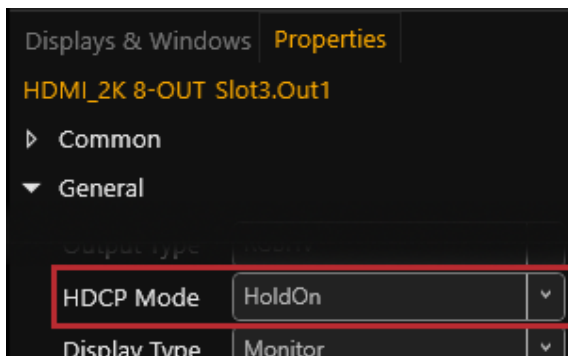

- HoldOn: Keeps HDCP active
- KeepOff : Turns off HDCP
- FollowSourcesTurns HDCP on or off depending on the source

- When you are happy, select Take and then Set device startup to save the take on your CORIOmaster, so your changes will be restored on start up.

- If you are creating an offline configuration, select Save to file.

# Creating a video installation

To create a video installation in CORIOgrapher™, you need sources and displays. Make sure you've either loaded your configuration from your CORIOmaster™, or created an offline configuration.



Read about reading the configuration from your CORIOmaster™ on page 31.

Read about creating an offline configuration on page 32.

## To create a video installation on a canvas

1. In  Editor, choose a canvas.



2. Select  Show assets and open Displays.
3. OPTIONAL, but RECOMMENDED: Assign equipment to the display by selecting the , then select the equipment you want to assign to the display, and then select Assign. When you add the display to a canvas the values from the equipment will automatically be used, so you don't have to set them manually.

 You can change or assign equipment later by selecting the display, then from the Properties panel, open Equipment, select Assign.

4. OPTIONAL: If the display resolution is not listed there are two possibilities:
  1. The module does not support the resolution you require, for example you want a 4K resolution on a 2K output. You will need to use a different module that supports your required resolution.
  2. The resolution is not in the built-in list. If supported by the module, you can add a custom resolution by selecting Add custom or Manage.

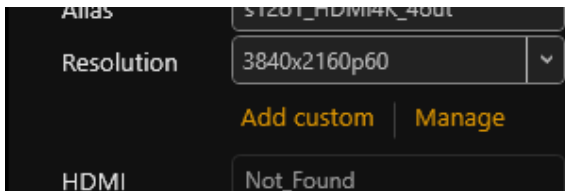

- Add custom opens a dialog that targets the module requirements. We've created a custom resolution algorithm that maximizes the likelihood that the resolution will work in your setup.

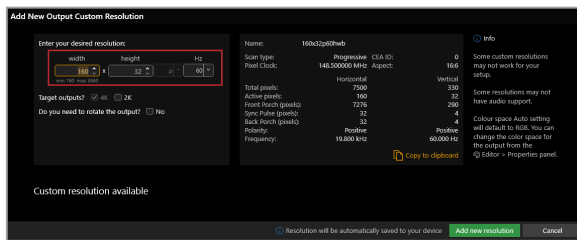

 Adding or selecting a resolution will also select the resolution for the display.

 If the resolution frame rate does not match the canvas frame rate you will see a warning from the Editor display.

Read about custom resolutions on page 61.

- Manage opens the advanced dialog where you can manually enter timing values or use one of the timing providers.

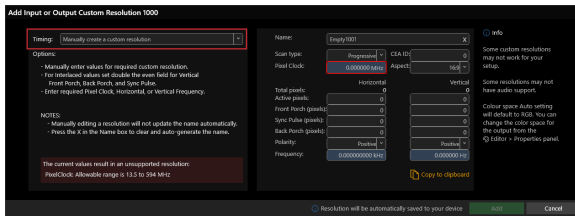

! Changing the values of a resolution may make it incompatible with the display.

! Deleting a resolution that is used will cause the display to revert to a default resolution.

Read about custom resolutions on page 61.

5. OPTIONAL: If your output module supports port cloning, you can clone an output onto a second display. Both displays show the same output at the same resolution.

From Properties > Clone Output select On.

6. For each display you want to use in your video installation, select  $\oplus$  to add a display.
7. Arrange the displays on the canvas until they match your plan.

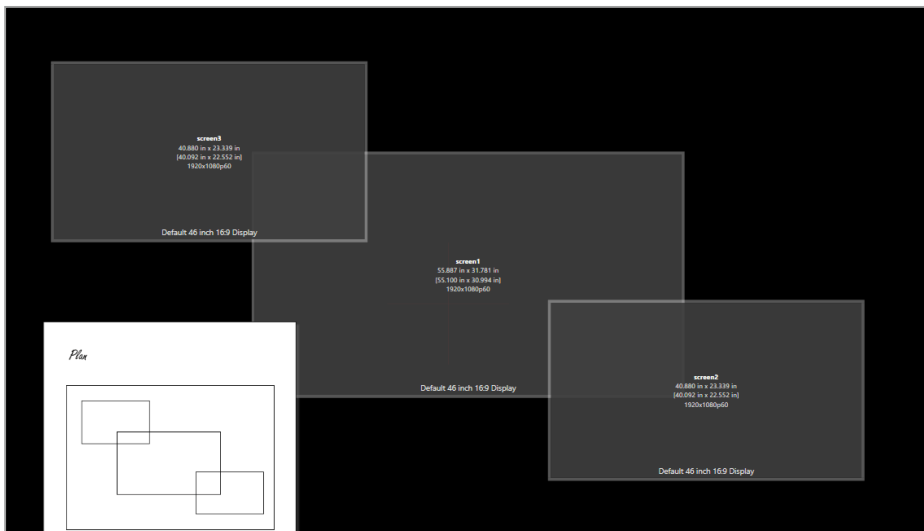

8. Add one or more windows. In  $\oplus$  Assets, open Sources.

! Read about updating existing presets when you add more windows on page 77.

9. For each source you want to play in your video installation, select  $\oplus$  to add a free window.
10. To customize a window, for example, to add a border, or change the quality of a free window, double-click the window to open Properties, and make your changes.

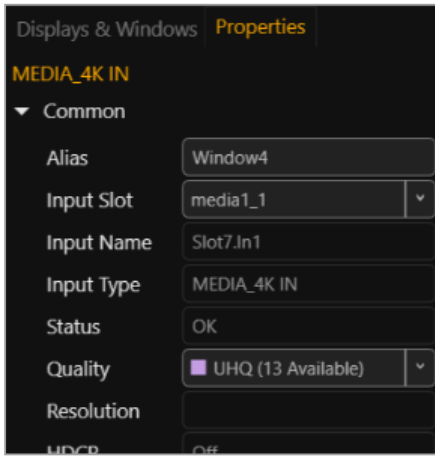

11. RECOMMENDED: If you are not connected to a device you can select the input's resolution used for the bandwidth calculations.

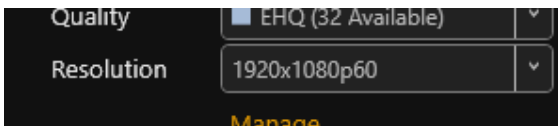

**!** Be aware that the resolution may change when you connect to your device and the real resolution is measured from the source.

12. OPTIONAL: If the source resolution is not listed there are two possibilities:
  1. The module does not support the resolution the source is trying to send.
  2. The resolution is not in the built-in list. If supported by the module, you can add a custom resolution by selecting **Manage**.



13. When you are happy with your video wall, select  Take and then  Set device startup to save the take on your CORIOmaster™, so your changes will be restored on start up.

Before you start using your video installation, it's a good idea to test it to make sure everything is connected properly.

Read about testing your video installation on page 42.

Read about HDCP on page 35.

## Testing your video installation

Once you've created your basic video installation, make sure that you've correctly connected all your hardware, and named and positioned your displays and windows correctly in CORIOgrapher™.



Testing your video installation is much easier if you've named your input and output ports and channels.  
Read more on page 33.

1. Add displays and windows.

Read more on page 39.

2. Select  Take to send the configuration on the canvas to your device.



3. Check that your video installation looks correct.

Make sure that each source is playing, and check that the picture is assembled correctly.

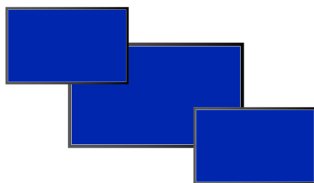

- ✗ Not the source you were expecting, blue screen, display keeps dropping signal, or no image.

Possible causes:

- Source connected incorrectly
- Input ports named incorrectly
- Source not playing
- Source resolution not supported
- Display does not support HDCP
- Source does not support the required number of HDCP keys
- Poor quality or damaged cables



- ✓ Source correct, connected, and playing.
- ✗ Image appears in the wrong places.

Possible causes:

- Displays arranged incorrectly in CORIOgrapher
- Output ports named incorrectly
- Displays connected incorrectly





- ✓ Source and displays connected and arranged correctly.

4. If you can't resolve these issues, you might need to contact tvONE support.

See contact details on page 150.



- When you are happy with your video wall, select  Take and then  Set device startup to save your settings on your device.

If your video wall is displaying the right sources in the right windows, but doesn't look quite right, you can use the settings in  Editor to refine your video wall and make it more accurate.

You can now set up and test audio.

## Set up and test audio

Your CORIOmaster, CORIOmaster mini, or CORIOmaster micro supports embedded audio in uncompressed PCM format. CORIOmaster micro also includes an independent S/PDIF audio output.

### Testing embedded audio inputs

- From  Editor, select  Live changes.

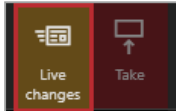

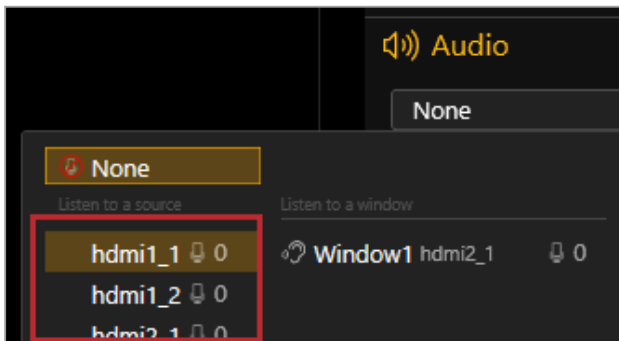

- Select an audio source from the list.



You hear the audio source from all the displays and output devices associated with this canvas.

- Select each source in turn.

If you cannot hear a source:

- check the audio settings of the source device.
- On  Editor, make sure the source is not muted. A muted source shows .
- In  Settings > Slot Status, make sure Audio Enabled is selected for the source.
- If you cannot hear any sources, check the audio settings of the output devices.
- If your source is a stream with low latency, your CORIOmaster mutes the audio.  
Read more about playing streams on page 98.
- The Streaming media and 4K playback input module only supports the following embedded audio formats:
  - mp3
  - aac

## Testing embedded audio outputs

1. From  Editor, select  Live changes.

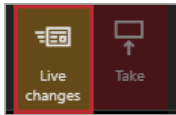



2. If you have a CORIOmaster micro, mute the S/PDIF output.  
From Audio, select Mute Audio.

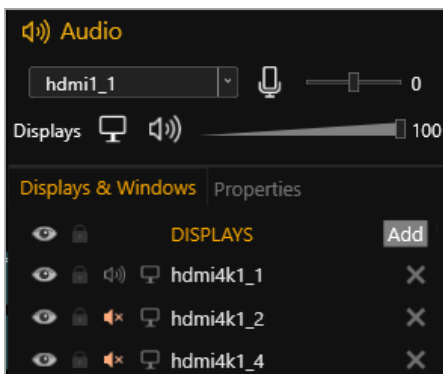

3. From Displays & Windows, mute all the displays, except the one you want to test.



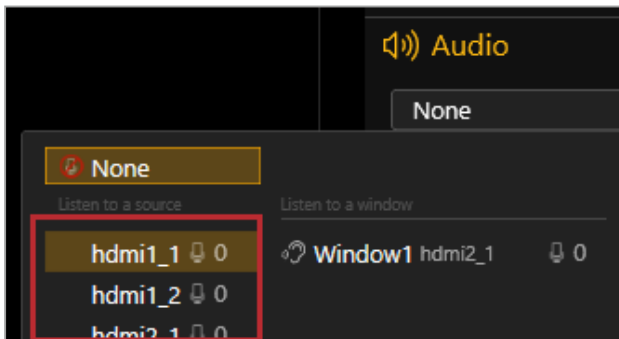

Select  to mute a display, and  to unmute a display.

4. Select an audio source from the list.



You hear the audio source from the display that isn't muted.

5. Mute and unmute each display until you have heard audio from all displays.  
If you can't hear audio:

- Check the audio settings on the display itself.
- In  Editor, make sure the source is not muted. A muted source shows .
- In  Settings > Slot Status, make sure Audio Enabled is selected for the source and for the display.
- If your source is a stream with low latency, CORIOmaster mutes the audio.  
Read more about playing streams on page 98.
- The Streaming media and 4K playback input module only supports the following embedded audio formats:
  - mp3
  - aac

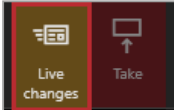

## Testing the S/PDIF output of a CORIOmaster micro

1. From  Editor, select  Live changes.

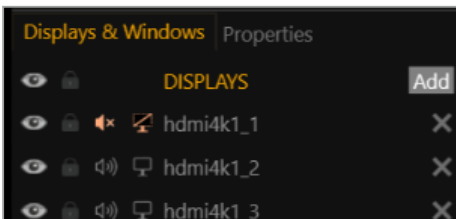

2. From Displays & Windows, mute all the displays.



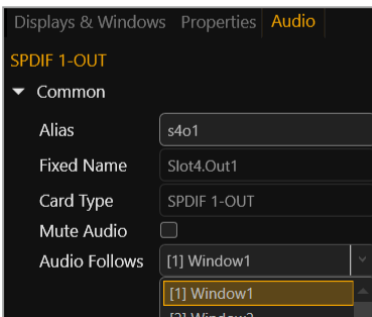

Select  to mute a display, and  to unmute a display.

3. From  Editor, select Audio
4. Select a window from Audio Follows.



If you can't hear audio:

- Check the audio settings on the display itself.
- In  Editor, make sure the source is not muted. A muted source shows .
- In  Settings > Slot Status, make sure Audio Enabled is selected for the source and for the display.
- If your source is a stream with low latency, CORIOmaster mutes the audio.  
Read more about playing streams on page 98.
- The Streaming media and 4K playback input module only supports the following embedded audio formats:
  - mp3
  - aac

Read about what to do if you can't hear audio on page 137.

## Settings

You can manage device settings, network settings, and user settings. You can also get information about your CORIOmaster™, and name your modules.

### In this section

Device settings .....	47
Naming your CORIOmaster™ .....	47
Resetting your CORIOmaster™ to factory default settings .....	47
Choosing your working units .....	48
Backing up and restoring your settings .....	48
Resetting your CORIOmaster™ to factory default settings .....	50
CORIOmaster micro™ settings .....	51
Configuring the buttons of your CORIOmaster micro™ .....	51
User settings .....	52
Creating and editing users .....	52
Changing other users' passwords .....	53
Changing your own password .....	54
Network settings .....	54
Configuring network settings for your CORIOmaster™ .....	54
Configuring network settings for streaming media .....	56
Playlist settings .....	58
Renaming playlists and moving playlists between modules .....	58
Deleting playlists .....	58
Encoders and streams settings .....	59
Managing encoders and streams .....	59
Resolution Editor .....	61
About custom resolutions .....	61
Creating and editing custom resolutions .....	61

## Device settings

Administrators can configure settings for your CORIOmaster™, including creating and changing its name, changing the measurement units you use to create video walls, backing up and restoring your configuration, and resetting the CORIOmaster to its factory default settings.

### In this section

Naming your CORIOmaster™ .....	47
Resetting your CORIOmaster™ to factory default settings .....	47
Choosing your working units .....	48
Backing up and restoring your settings .....	48
Resetting your CORIOmaster™ to factory default settings .....	50

## Naming your CORIOmaster™

You can give your CORIOmaster a unique name.

### Why should I name my CORIOmaster?

If you have more than one CORIOmaster unit on your network, giving each unit a unique name can make it easier to find and log in to that unit quickly.

### To name your CORIOmaster

1. Select  Settings > General.
2. Enter a name for your CORIOmaster.

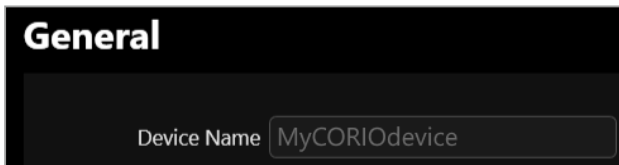

3. Select Save.

## Resetting your CORIOmaster™ to factory default settings

### Why restore factory default settings?

If your CORIOmaster has become unstable, you have repeated errors that you can't fix, or you need to remove all settings and presets, you can reset your CORIOmaster to its factory default settings.

 When you reset your CORIOmaster to factory default settings, all of your settings and configurations are deleted.

Before you reset your CORIOmaster, you might want to back up your configuration. When you set up your CORIOmaster, you can restore your configuration.

Read about backing up and restoring your configuration on page 48.

## To reset your CORIOmaster to factory default settings

1. Select ⚙ Settings > General.
2. Select Factory Reset.

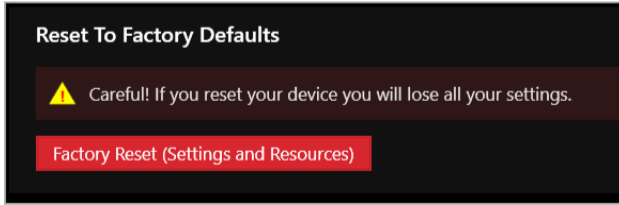

## Choosing your working units

You can choose to work in inches or millimeters when you build video installations in CORIOgrapher™.

### To choose a unit

1. Select ⚙ Settings > CORIOgrapher.
2. From Default Units, choose your preferred units.

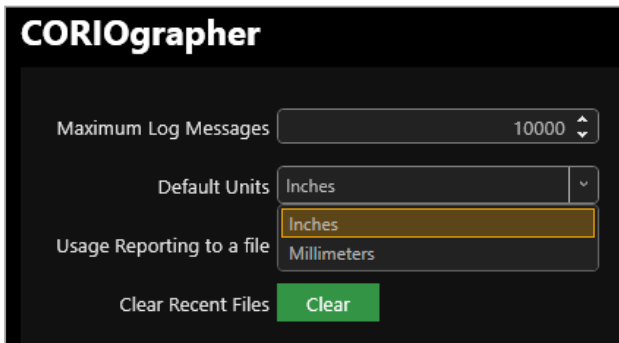

## Backing up and restoring your settings

You can save your settings to a file on your CORIOmaster™, or to a file on your computer. You can restore your settings from either file. You can share a file saved on a computer between several CORIOmaster units that have the same configuration of modules.



### Backing up your settings on your CORIOmaster

#### Settings that are saved on your CORIOmaster

All settings are saved to a backup file on your CORIOmaster, including:

- Presets
- Configuration, including custom names
- Canvases
- The play queue of a Streaming media and 4K playback input module
- Network settings
- Manually added streams

## What isn't saved to your CORIOmaster

Any work that you have not saved to the device, with  Take and  Set device startup, will not be saved to the CORIOmaster backup file.

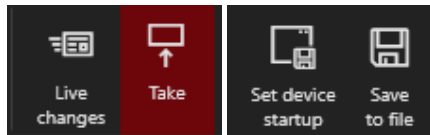

 It is recommended you save your configuration to a file to keep a backup on your computer.  
Read about backing up to a file on page 49..

## To back up your settings on your CORIOmaster

1. Check that you've saved all your work.
2. Select  Settings > Backup and Restore > Backup.

## Restoring your settings from your CORIOmaster

1. Select  Settings > Backup and Restore.
2. Select Restore.

## Backing up your settings to a file on your computer

### Settings that are saved on your computer

Most settings are saved to a backup file on your computer, including:

- Presets
- Configuration, including custom names
- Canvases
- Network settings
- Manually added streams
- Custom resolutions

Note: device name and network settings are saved as part of the backup file, but are not included when you restore settings to your device. This allows you to share the backup file between devices without causing conflicts with names and network settings.

### What isn't saved to your computer

The play queue and playlists of a Streaming media and 4K playback input module aren't saved to your computer.

## To back up your settings to a file on your computer

1. Select  Editor >  Save to file.



2. Choose a location for the file, and save.

## Restoring or copying settings from a file on your computer

1. Connect to the CORIOmaster that you want to update with saved settings.
2. Select  Home.
3. Under Recent Configurations, select a saved file.

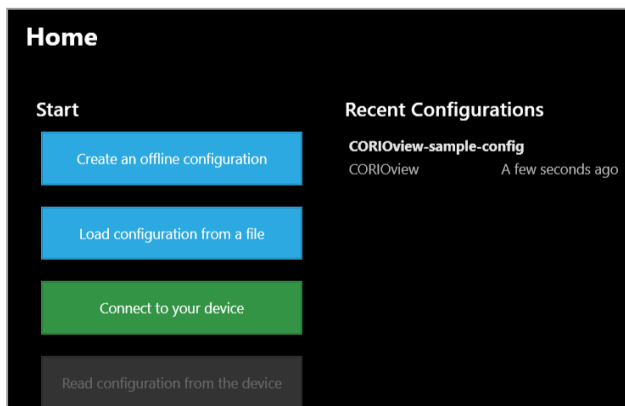

If you can't see your file in the list, select Load configuration from a file and browse to your file.

## Problems sharing settings between CORIOmaster units

You can't share saved settings between different sizes of CORIOmaster unit. For example, if you save the settings from a CORIOmaster mini™, you can't use it in a CORIOmaster.

You can't share saved settings between devices with different configurations of modules.

You might not be able to copy settings from one CORIOmaster to another if they have very different firmware versions, or you might lose some data in the process.

## Resetting your CORIOmaster™ to factory default settings

### Why restore factory default settings?

If your CORIOmaster has become unstable, you have repeated errors that you can't fix, or you need to remove all settings and presets, you can reset your CORIOmaster to its factory default settings.

 When you reset your CORIOmaster to factory default settings, all of your settings and configurations are deleted.

Before you reset your CORIOmaster, you might want to back up your configuration. When you set up your CORIOmaster, you can restore your configuration.

Read about backing up and restoring your configuration on page 48.

### To reset your CORIOmaster to factory default settings

1. Select  Settings > General.
2. Select Factory Reset.

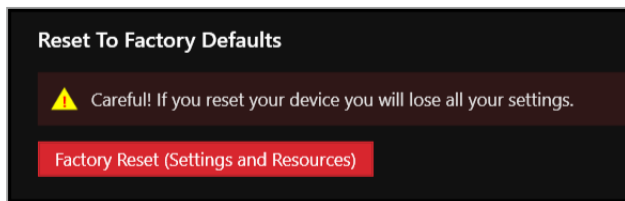



# CORIOmaster micro™ settings

## In this section

Configuring the buttons of your CORIOmaster micro™ .....51

## Configuring the buttons of your CORIOmaster micro™

You can choose which presets, sources, and windows correspond to the buttons on the front panel of your CORIOmaster micro™. Configure the buttons in CORIOgrapher™.

### Mapping presets, sources, and windows to the buttons of the front panel

1. Select  > (Front Panel) Button Mapping.
2. Select the option you want to configure.

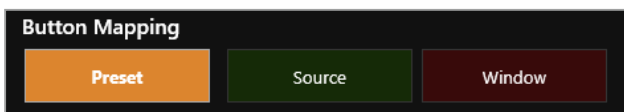

3. For each button, select a preset, source, or window from the list.

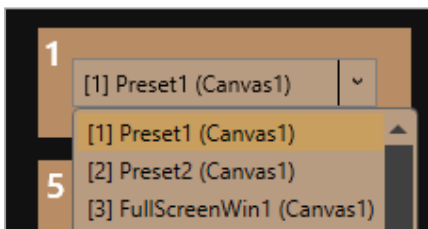

4. Repeat steps 2 and 3 until you have configured all modes and buttons, and then select Save.

### Changing the brightness of the buttons of the front panel

1. Select  > (Front Panel) Settings.
2. Use the slider to adjust the brightness.

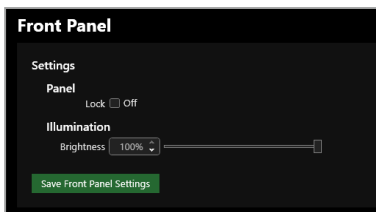

### Locking the buttons of the front panel

1. Select  > (Front Panel) Settings.
2. Select or clear Lock.

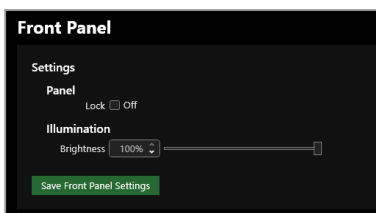

3. Select Save front panel settings.

## User settings

Administrators can create and edit users, change user roles, and enable specific timeout times. Users and power users can change their own passwords.

### In this section

Creating and editing users .....	52
Changing other users' passwords .....	53
Changing your own password .....	54

## Creating and editing users

You can create and edit users, change user roles, and enable specific timeout times. You can have up to four additional users.

### Who can do this?

Administrators can do this task.

What are user roles? CORIOgrapher has three types of user, administrator, power user, and user.	Users	Power Users	Administrators
Use the dashboard, including loading presets and using audio controls	✓	✓	✓
Send configurations to your CORIOmaster		✓	✓
Create offline configurations		✓	✓
Save and load configurations		✓	✓
Use the console		✓	✓
Create and edit video installations		✓	✓
Create and edit presets		✓	✓
Set window and display properties, including disabling audio		✓	✓
Change settings, including creating and editing other users			✓
Set up a new CORIOmaster			✓

### Why set a timeout time?

By default, a connection to a CORIOmaster™, CORIOmaster mini™, or CORIOmaster micro™ must stay active, or it is disconnected after five minutes. An active connection sends at least one command to the CORIOmaster every five minutes.

To stay connected while idle for more than five minutes, set a longer timeout time for each user. You can also allow the user to stay connected permanently, with no timeout time, by clearing the Enable timeout option.

#### Locking out other users



CORIOgrapher only allows one connection at a time. If you allow any user to connect permanently, or with a long timeout time, they can lock out other users. This can also prevent commands from other devices reaching the CORIOmaster. If you want to allow multiple users to control a CORIOmaster, use our REST API with WebSocket events. Visit our API site at [api.tvone.com](http://api.tvone.com).

### To create a new user, or edit an existing user

The screenshot shows a user configuration form for 'User 4'. It includes the following fields and options:

- Username:** Janneke\_poweruser
- User Role:** PowerUser (selected from a dropdown menu)
- New Password:** [masked with dots]
- Confirm Password:** [masked with dots]
- Enable timeout:** A checked checkbox.
- Timeout time:** A dropdown menu set to '5' minutes.

1. Select Settings > Users.
2. To create a new user, choose an empty slot. To edit an existing user, find that user's details.
3. Enter a username.  
Usernames must start with a letter, and can contain only letters, numbers, and underscores.
4. Select a user role.
5. Enter and confirm a password.  
Passwords must be between 5 and 32 characters and can contain any combination of alphanumeric characters and symbols. Passwords cannot contain spaces.
6. Select Enable timeout, and enter or select a timeout time from 1-540 minutes.

tvONE recommends a timeout time from 1-5 minutes.

7. Select Save.

## Changing other users' passwords

You can make changes to other users' accounts.

### Who can do this?

Administrators can do this task.

### Password rules

Passwords must be between 5 and 32 characters and can contain any combination of alphanumeric characters and symbols. Passwords cannot contain spaces.

### To change other users' passwords

1. Select Settings > Users.
2. Find the user whose password you wish to change and enter and confirm the new password.

## Changing your own password

### Who can do this?

Administrators, power users, and users can do this task.

### Password rules

Passwords must be between 5 and 32 characters and can contain any combination of alphanumeric characters and symbols. Passwords cannot contain spaces.

### To change your password

1. Select  Settings > Users.
2. Find your user details and enter and confirm your new password.

## Network settings

Administrators can configure network settings for CORIOmaster™ units and Streaming media and 4K playback input modules.

### In this section

Configuring network settings for your CORIOmaster™ .....	54
Configuring network settings for streaming media .....	56

## Configuring network settings for your CORIOmaster™

You can choose a DHCP or static IP address, and configure your static IP settings.

### Before you start

If you want to use a static IP address, you need some information about the range of available IP addresses on your network. Your network administrator should be able to help you.

#### Static IP address

-  If you choose a static IP address, make sure you enter a unique value for your IP address. Using the same IP address for multiple devices can cause your devices to disconnect. Contact your network administrator for help.

## To configure network settings for your CORIOmaster

1. In CORIOgrapher, select ⚙ Settings > Networking.
2. Choose an IP configuration.

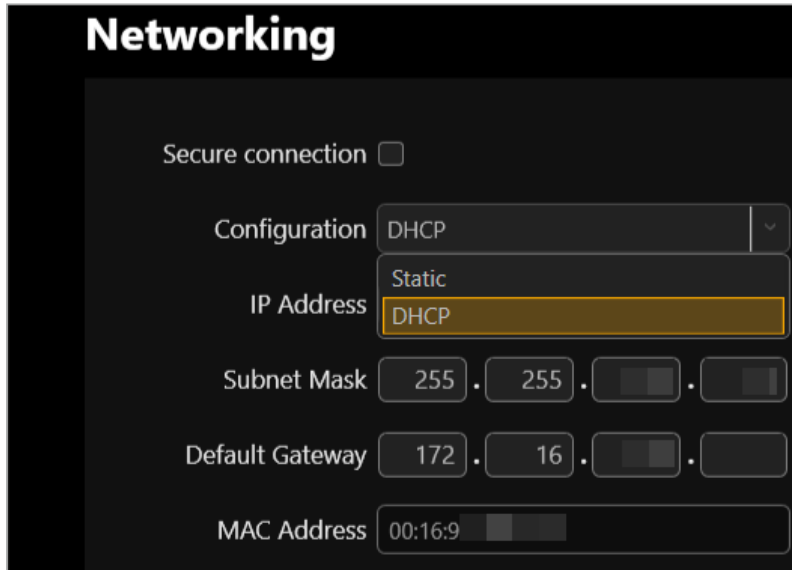

The screenshot shows the 'Networking' settings interface. At the top, there is a 'Secure connection' checkbox which is unchecked. Below it is a 'Configuration' dropdown menu currently set to 'DHCP'. An expanded dropdown menu for 'IP Address' is shown, with 'DHCP' selected and highlighted in yellow, and 'Static' as an option. Below the IP Address dropdown are four input fields for 'Subnet Mask' with values 255, 255, and two empty fields. Below that are four input fields for 'Default Gateway' with values 172, 16, and two empty fields. At the bottom is a 'MAC Address' field with the value 00:16:9 followed by two empty fields.

- If you choose DHCP, an IP address is assigned to you.
  - If you choose Static, configure your IP address.
3. OPTIONAL: Configure your static IP address.

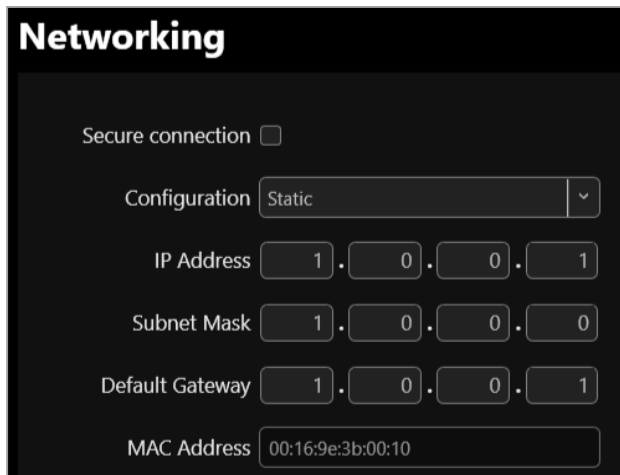

The screenshot shows the 'Networking' settings interface with 'Configuration' set to 'Static'. The 'IP Address' field is filled with 1, 0, 0, 1. The 'Subnet Mask' field is filled with 1, 0, 0, 0. The 'Default Gateway' field is filled with 1, 0, 0, 1. The 'MAC Address' field is filled with 00:16:9e:3b:00:10.

- Enter a value for your IP address and subnet mask.
- If your CORIOmaster and PC are on different networks, enter a value for your gateway.

If you need help with network settings, contact your network administrator.

## Configuring network settings for streaming media

If you want to stream media over your network, or from the internet, configure the network settings for your Streaming media and 4K playback input module.

If you only want to use your Streaming media and 4K playback input module to play media from a USB drive, you don't need to configure network settings.

Read about configuring your Magenta Encoder-100 at [help.tvone.com/r/docs/cm/encoder-100/1](http://help.tvone.com/r/docs/cm/encoder-100/1).

### About static IP addresses

If you want to use a static IP address, you need some information about the range of available IP addresses on your network. Your network administrator should be able to help you.

Static IP address

- ! If you choose a static IP address, make sure you enter a unique value for your IP address. Using the same IP address for multiple devices can cause your devices to disconnect. Contact your network administrator for help.

### To configure network settings for streaming media

1. In CORIOgrapher, select ⚙ Settings > Module Configuration.
2. Find the Streaming media and 4K playback module that you want to set up, and select ⋮ > Configure.

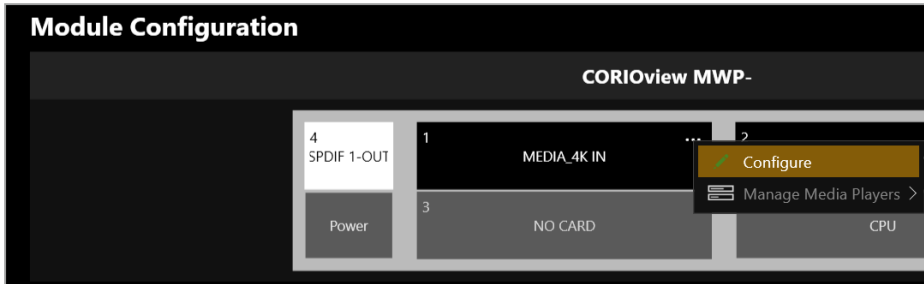

3. Choose an IP configuration.

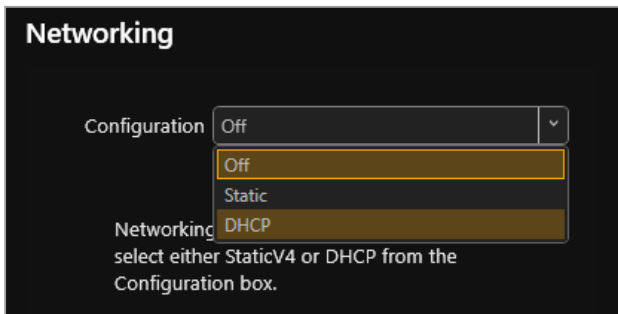

- If you choose DHCP, an IP address is assigned to you.
- If you choose Static, the last static IP address you saved is available to edit. If you haven't previously saved a static IP address, default values for a static IP address are available to edit.

4. OPTIONAL: Configure your static IP address.

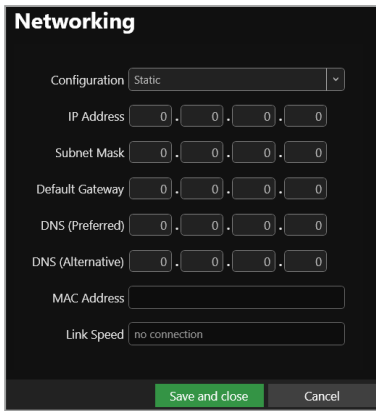

- Enter a value for your IP address and subnet mask.
- If you want to stream from the internet, for example from a Wowza server, enter a value for your gateway.
- If you want to refer to a source by name, enter a value for DNS.

If you need help with network settings, contact your network administrator.

### Finding the MAC address of your Streaming media and 4K playback input module

1. In CORIOgrapher, select ⚙ Settings > Module Configuration.
2. Find the Streaming media and 4K playback module that you want to set up, and select ⋮ > Configure.

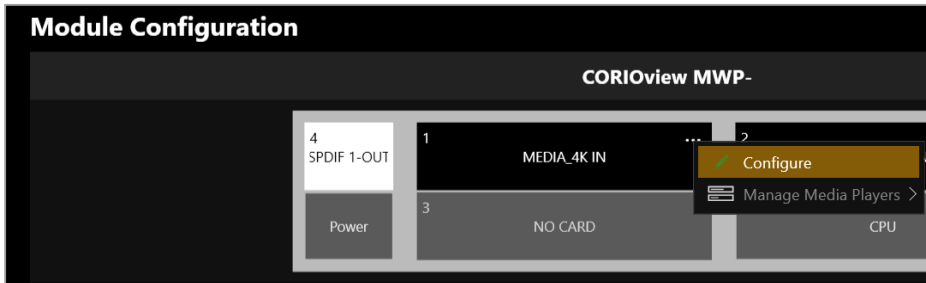

3. Read the MAC address.

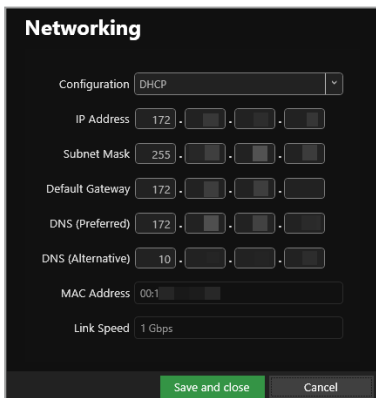

## Playlist settings

If you have a Streaming media and 4K playback input module, you can view the status of your playlists, delete all playlists or individual playlists, move playlists between modules, and rename playlists.

### In this section

Renaming playlists and moving playlists between modules .....	58
Deleting playlists .....	58

## Renaming playlists and moving playlists between modules

You can see a list of all your playlists on all your Streaming media and 4K playback input modules. You can rename your playlists and move them between modules.

**!** Playlists created in one mode are not displayed in other modes as they are not compatible with the playback method.

### Renaming your playlists

1. In CORIOgrapher, select  Settings > Playlists.
2. Find the playlist you want to rename, and enter a new name.

Number	Name	Module	Resolution	
1	<input type="text" value="Playlist1"/>	Slot1	1920x1080p60	<a href="#">Remove</a>
2	<input type="text" value="Playlist2"/>	Slot1	1920x1080p60	<a href="#">Remove</a>
3	<input type="text" value="Playlist3"/>	Slot1	1920x1080p60	<a href="#">Remove</a>

### Moving playlists

1. In CORIOgrapher, select  Settings > Playlists.
2. Find the playlist you want to move and select the new module from the list.

Number	Name	Module	Resolution	
1	<input type="text" value="Playlist1"/>	Slot1	1920x1080p60	<a href="#">Remove</a>
2	<input type="text" value="Playlist2"/>	Slot1	1920x1080p60	<a href="#">Remove</a>
3	<input type="text" value="Playlist3"/>	Slot1	1920x1080p60	<a href="#">Remove</a>

## Deleting playlists

If you have a Streaming media and 4K playback input module, you can delete all your playlists, or individual playlists.

### Deleting all your playlists

1. In CORIOgrapher, select  Settings > Playlists.
2. Select Remove all saved playlists.

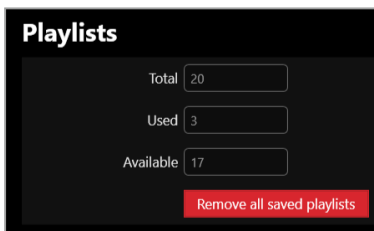



## Deleting individual playlists

1. In CORIOgrapher, select ⚙ Settings > Playlists.
2. Find the playlist you want to delete.
3. Select Remove.

Number	Name	Module	Resolution	
1	Playlist1	Slot1	1920x1080p60	Remove
2	Playlist2	Slot1	1920x1080p60	Remove
3	Playlist3	Slot1	1920x1080p60	Remove

## Encoders and streams settings

You can view and manage all your encoders and saved streams.

### In this section

Managing encoders and streams .....	59
-------------------------------------	----

## Managing encoders and streams

You can view and manage all your encoders and saved streams.

Select ⚙ Settings > IP Streams.

### Managing your encoders

Encoders that CORIOgrapher™ detects appear under Discovered encoders.

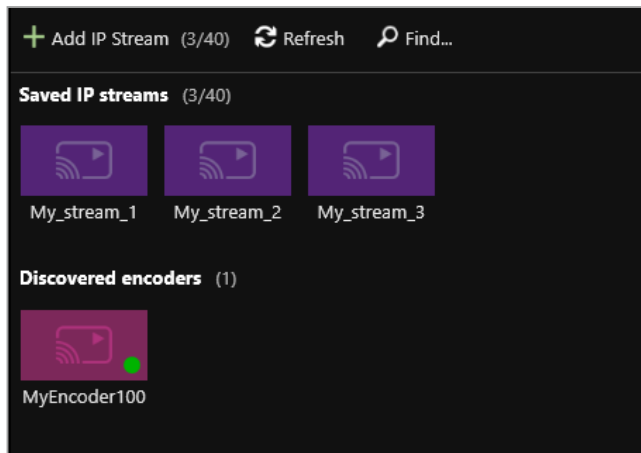

You can:

- Refresh the list of encoders.
- Search for an encoder that doesn't appear automatically.
- Select an encoder to see details about that encoder.
- Select ⋮ to:
  - Manage the encoder, or change your configuration.  
Read about configuring your Magenta Encoder-100 at [help.tvone.com/r/docs/cm/encoder-100/1](http://help.tvone.com/r/docs/cm/encoder-100/1).
  - Remove an inactive encoder.
  - Preview the stream from an encoder.

- Start or stop encoding.

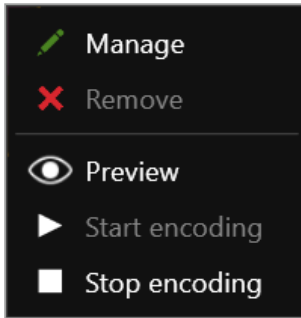

## Managing your saved streams

Streams that you add and save manually appear under Saved IP streams.

- You can see how many streams you have, and how many slots you have left.
- You can add new streams, and remove all your saved streams.

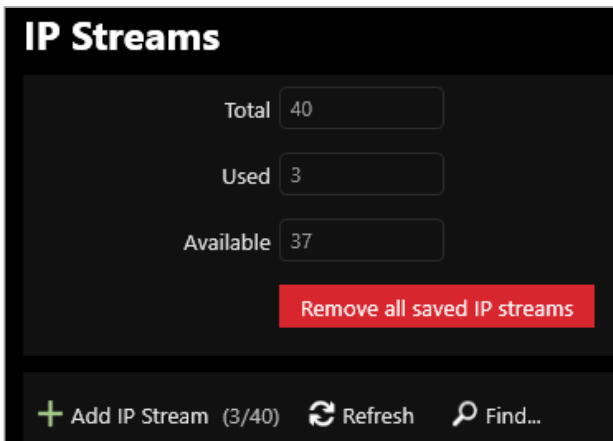

- You can edit the name and URL of saved streams.
  1. Select the stream and then select **⋮** > Edit.
  2. Edit the name or URL of the media stream.

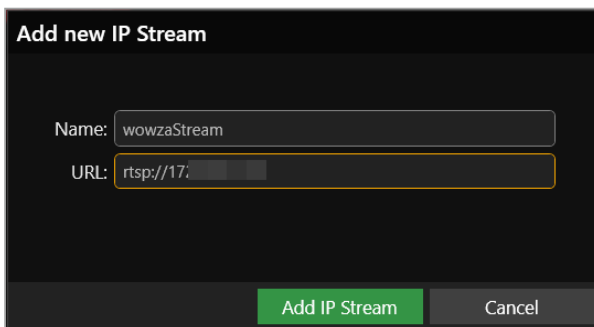

Read about configuring your Magenta Encoder-100 at [help.tvone.com/r/docs/cm/encoder-100/1](http://help.tvone.com/r/docs/cm/encoder-100/1).

# Resolution Editor

Administrators can manage custom resolutions.

## In this section

- About custom resolutions .....61
- Creating and editing custom resolutions ..... 61

## About custom resolutions

### What are custom resolutions

Your device has a number of commonly used resolutions that you can choose from for your displays or detected from a source connected to the input module.

Custom resolutions are resolutions that you can define yourself to get extra support that is not built-in to your device already.

**!** It's important to understand that not all custom resolutions will work with your setup because there are many factors that can influence if a resolution is usable, for example the hardware used in sources and displays, the cables used and their length, or the requirements of the device.

### When to use custom resolutions

Create a custom resolution when the resolution your source or display requires is not one of the built-in resolutions.

### Custom resolution for inputs and outputs

Inputs and outputs have different requirements which is why not all resolutions are available for different module types.

**!** 4K modules can support a wider range of resolution values than 2K modules.

**!** SDI modules do not support custom resolutions.

## Creating and editing custom resolutions

### Add a custom resolution to use with outputs

Due to the requirements of the outputs to be able to show video synchronized, all displays on the same canvas must have the same frame rate, for example all displays are showing video at 60 Hz.

We've created a custom resolution algorithm that maximizes the likelihood that the resolution will work in your setup.

1. In CORIOgrapher, select  Settings > Resolution Editor.
2. Select  Add output resolution (easy) to show the dialog.

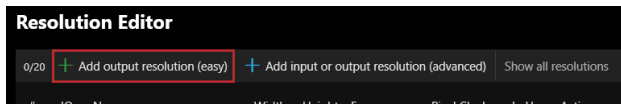

3. Enter the desired resolution into the width, and height, and select the frame rate.

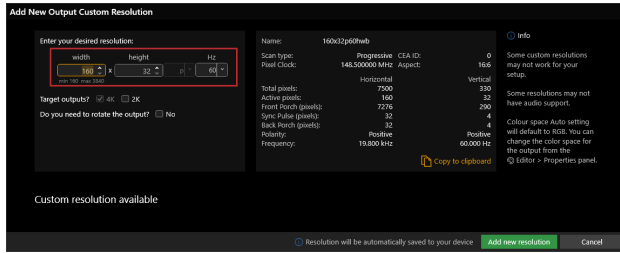

✔ There are maximum supported values for the width and height, so not all values will be allowed at the same time, trying lower the width, height, or frame rate to create a compatible resolution.

! We will search the CEA-861-F (Consumer Electronics Association) resolution list for matches and if found you can add this instead of creating a new custom resolution.

4. OPTIONAL: Check the 2K option if you require a resolution for a 2K output, as this will limit the maximum values used to make the resolution compatible with a 2K output module.
5. OPTIONAL: Configure the other options to help make a resolution that is compatible for your needs.
6. Select **Add new resolution** to add the resolution to the resolution list for your configuration. The resolution will now be selectable for compatible outputs and connected sources.

! If you are connected to a device the resolution will be automatically sent and saved to your device.

## Add a custom resolution with the advanced options

Sometimes you might already know the resolution timing values from the manual or specification sheets of the connected devices. These could be specific to the device, or from an existing standard.

✔ If you are creating a custom resolution for outputs it is recommended to use the **+** Add output resolution (easy) dialog.

1. In CORIOgrapher, select **Settings > Resolution Editor**.
2. Select **+** Add input or output resolution (advanced) to show the dialog.

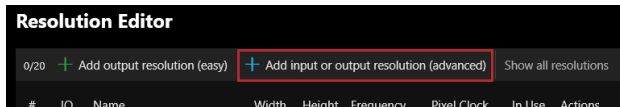

3. From this dialog you can select the timing method you would like to use to add the resolution:

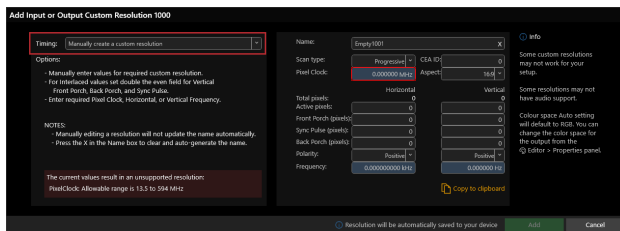

! You may get warnings about the resolution values if they produce a resolution that is outside the allowable ranges.

### Manual

Allows you enter the values directly. The blue boxes are linked depending on the total values, so changing one will update the other two.

! For interlaced resolutions the vertical sync pulse, and front and back porches must be twice the even field.

- CORIOmaster output resolution generator (tvONE)

Enter the values to create a custom resolution for your outputs that is compatible with the requirements of the output modules.

! This is the same method as the + Add output resolution (easy), but will not search the existing resolutions, or the CEA list for matching resolutions.

- CVT v1.2 Standard (VESA Coordinated Video Timing)  
This method uses the CVT formula to create a resolution which are best for analog devices.
- CVT v1.2 Reduced Blanking (VESA Coordinated Video Timing)  
This method uses the CVT Reduced Blanking formula to create a resolution which are best for analog devices.
- DMT 1.0r11 (VESA Display Monitor Timing)  
Select from the list of DMT resolutions which are best for analog devices.
- CEA-861-F (Consumer Electronics Association)  
Select from the list of CEA resolutions which are best for digital devices.

4. Select Add to add this to the resolution list for your configuration.  
The resolution will now be selectable for compatible outputs and connected sources.

✓ If you are connected to a device the resolution will be automatically sent and saved to your device.

## Edit a custom resolution for outputs

You might just want to make a tweak to resolution instead of deleting and create it again.

1. In CORIOgrapher, select ⚙ Settings > Resolution Editor.
2. Find the resolution you want to edit and select (green) ✎ to show the edit custom output resolution dialog.

#	IO	Name	Width	Height	Frequency	Pixel Clock	In Use	Actions
1000	IO	160x32p60hwb	160	32	60.000	148.500		✎
1001	IO	1250x1300p60hwb	1250	1300	60.000	148.500		✎

✓ If you are connected to a device the resolution will be automatically sent and saved to your device.

## Edit a custom resolution with the advanced options



You might just want to make a tweak to resolution instead of deleting and create it again.

1. In CORIOgrapher, select ⚙ Settings > Resolution Editor.
2. Find the resolution you want to edit and select blue ✎ to show the edit advanced resolution dialog.





#	IO	Name	Width	Height	Frequency	Pixel Clock	In Use	Actions
1000	IO	160x32p60hwb	160	32	60.000	148.500		✎
1001	IO	1250x1300p60hwb	1250	1300	60.000	148.500		✎

✓ If you are connected to a device the resolution will be automatically sent and saved to your device.

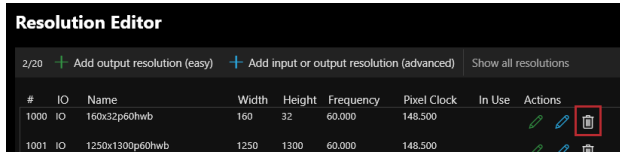
## Delete a custom resolution

1. In CORIOgrapher, select  Settings > Resolution Editor.
2. Find the resolution you want to delete and select .



#	IO	Name	Width	Height	Frequency	Pixel Clock	In Use	Actions
1000	IO	160x32p60hwb	160	32	60.000	148.500		 
1001	IO	1250x1300p60hwb	1250	1300	60.000	148.500		 



Resolutions that are in use and then deleted will be set back to their assigned equipment's default resolution. You may have to adjust them manually from the  Editor.



If you are connected to a device the resolution will be automatically deleted on your device.

## Show built-in resolutions

1. In CORIOgrapher, select  Settings > Resolution Editor.
2. Select Show All Resolutions to show all the resolutions including built-in and custom.

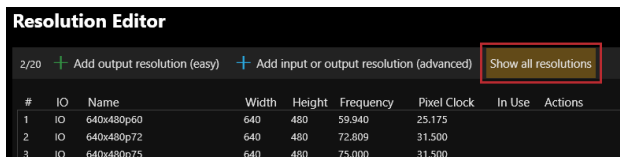

#	IO	Name	Width	Height	Frequency	Pixel Clock	In Use	Actions
1	IO	640x480p60	640	480	59.940	25.175		
2	IO	640x480p72	640	480	72.809	31.500		
3	IO	640x480p75	640	480	75.000	31.500		

## Using your CORIOmaster™

When your equipment is installed and you've recreated your installation in CORIOgrapher™, you can play streaming media, and add transitions and effects to your video wall.

### In this section

Presets .....	65
Creating and editing presets .....	66
Loading a preset .....	73
Show me some preset scenarios .....	75
Adding more windows with existing presets. ....	77
Changing the source playing in a free window .....	79
Using audio .....	81
Playing embedded audio .....	81
Playing independent audio with a CORIOmaster micro™ .....	94
Media and streams .....	98
Playing media and streams .....	98
Creating and managing playlists .....	109
Using the internal drive .....	116
Choosing the best resolution for your playlist or play queue .....	119
Using the buttons of your CORIOmaster micro™ .....	121
Changing between preset and source selection mode with your CORIOmaster micro™ .....	121
Locking your CORIOmaster micro™ .....	121
Replacing a module .....	122
Adding and managing custom EDID files .....	126

## Presets

You can create and save up to 50 presets in CORIOgrapher™.

### In this section

Creating and editing presets .....	66
Loading a preset .....	73
Show me some preset scenarios .....	75
Adding more windows with existing presets. ....	77

## Creating and editing presets

You can create and save up to 50 presets in CORIOgrapher™.

### What is a preset?

A preset stores information about windows, including positions, transitions, and effects such as borders or rotation. You can save presets and recall them later from the dashboard, or using the buttons of your CORIOmaster micro.

### What is included in a preset?

Presets store information about windows, including:

- Optionally, source playing in the window
- Position
- Z order, or stacking order
- Size
- Rotation
- Border
- Flip
- Source change transitions
- Fade to black

### What is not included in a preset?

- System settings
- Displays
- Canvases other than the one you are working on

For example, if you have canvas 1 and canvas 2 set up, but you have canvas 1 open in  Editor when you save a preset, the preset contains only information about canvas 1.

- Audio settings, including which window is playing audio, which source is playing breakaway audio, and whether you have chosen breakaway mode or audio-follows-video mode.
- Window:
  - Quality
  - Full name
  - Alias
  - Canvas



You can save all this information as a backup file.  
Read more on page 48.

### For best results

To prevent your presets behaving unexpectedly, follow the advice below.

#### Build your busiest preset first

Build the preset with the highest number of windows first. Include all the windows you want to use in all your presets for the canvas you're working on.

Move any windows that aren't for this preset away from the displays, and shrink them to reduce bandwidth.



## Don't use presets to add and remove windows

If you want to remove a window from your displays with a preset, don't delete the window.

- Move the window away from the displays.
- Reduce the size of the window to reduce unnecessary video bandwidth.

Note: windows that aren't on the display still take up bandwidth.

✓ Preset 1

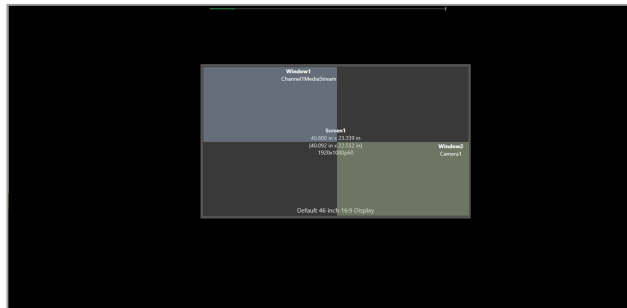

✗ Preset 2

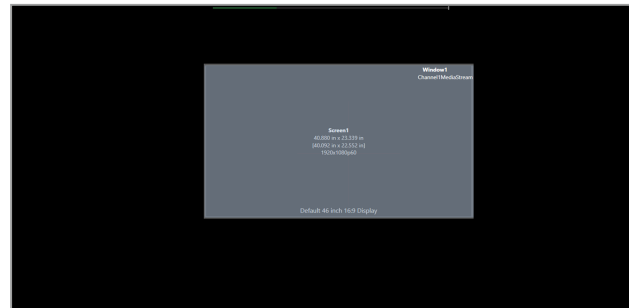

✓ Preset 2

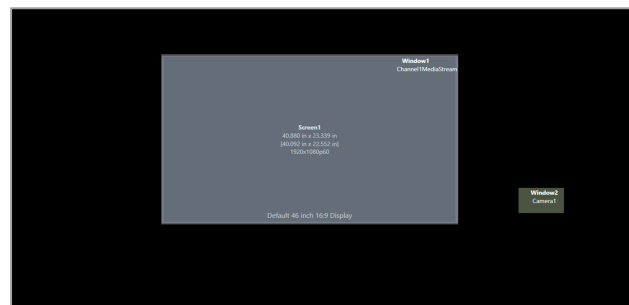

If you delete a window from a canvas, that window is also deleted from any presets for that canvas.

## Don't use presets to change window quality

Don't change the quality of a window that is included with a preset.

For example, if you save a preset that contains two windows of UHQ quality, and then change the quality of one window to EHQ, it will not return to UHQ when you load the preset.

If you want to reduce the video bandwidth consumed by a window, consider shrinking it instead.

## Windows used in presets only appear on one canvas

You can't use windows that are included in presets on more than one canvas.

## Creating a new preset with all windows

1. Create an installation on a canvas and select  Show presets.

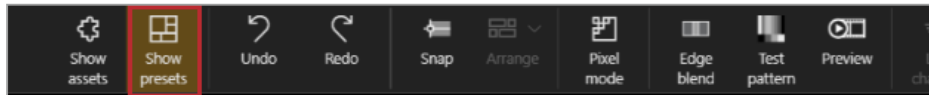

2. From , select **+ New**.
3. OPTIONAL: Select the number where the preset will be created. The next available location is automatically selected.
4. Enter a name for your preset.  
Names can be up to 19 characters long, and cannot contain " .

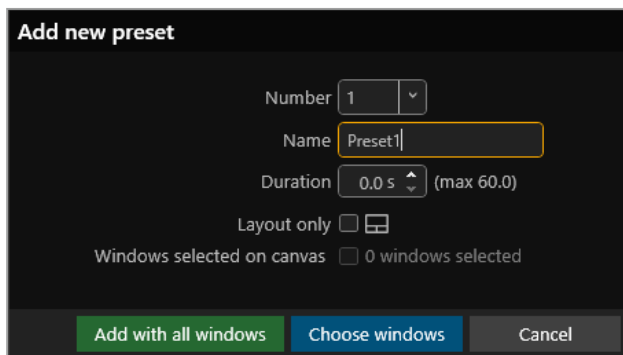

5. Enter or select a duration for your preset.  
The duration is the time taken to transition to this preset.
6. OPTIONAL: Select *Layout only* to create a preset that doesn't update the window sources, for example if you want to move windows and keep the sources the same.
7. Select **Add with all windows**.

## Creating a new preset with windows that are selected on the canvas

1. Create an installation on a canvas and select  Show presets.

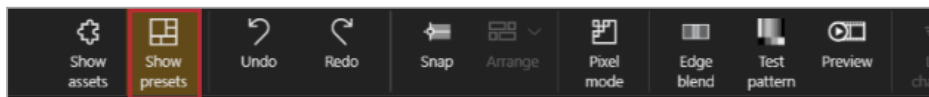

2. From the canvas, select the windows you want to include in the preset.

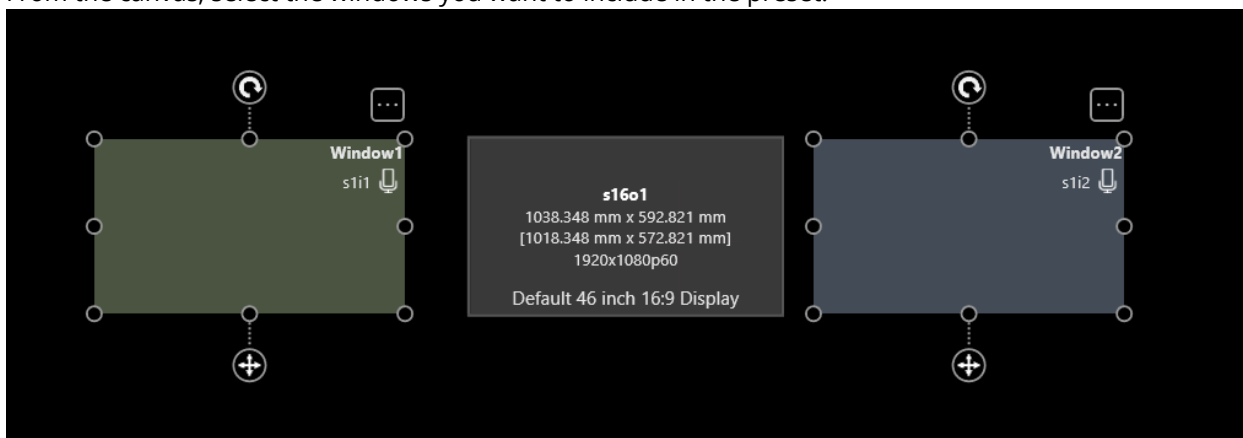

3. From , select **+ New**.
4. OPTIONAL: Select the number where the preset will be created. The next available location is automatically selected.

- Enter a name for your preset.  
Names can be up to 19 characters long, and cannot contain " .

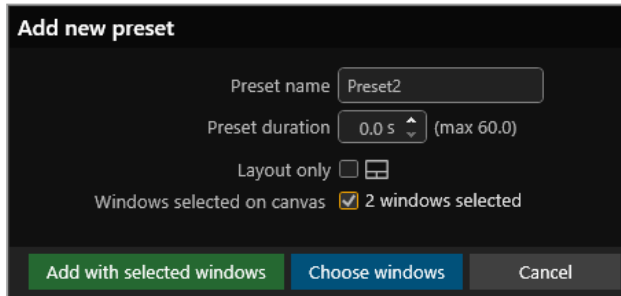

- Enter or select a duration for your preset.  
The duration is the time taken to transition to this preset.
- OPTIONAL: Select *Layout only* to create a preset that doesn't update the window sources, for example if you want to move windows and keep the sources the same.
- Select the *Windows selected on canvas* option.
- Select *Add with selected windows*.

## Creating a new preset and choosing which windows to include

- Create an installation on a canvas and select  *Show presets*.

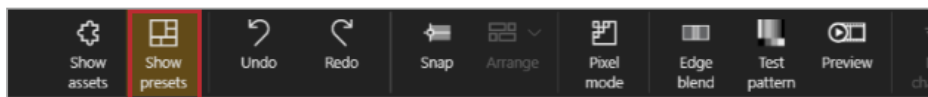

- From  *Presets*, select **+** *New*.
- OPTIONAL: Select the number where the preset will be created.  
The next available location is automatically selected.
- Enter a name for your preset.  
Names can be up to 19 characters long, and cannot contain " .

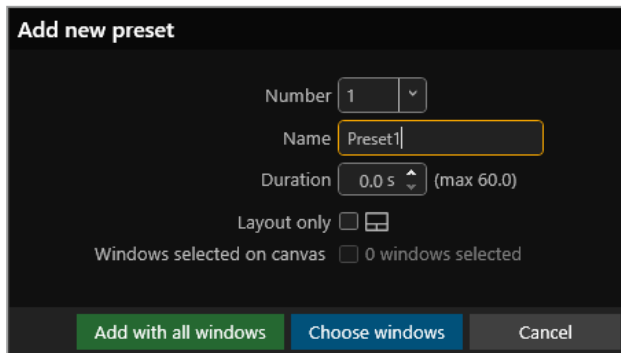

- Enter or select a duration for your preset.  
The duration is the time taken to transition to this preset.
- OPTIONAL: Select *Layout only* to create a preset that doesn't update the window sources, for example if you want to move windows and keep the sources the same.
- Select *Choose windows*, the preset editor will show.

8. Select or clear which windows you want to include in your preset.



9. Select Close from the preset editor toolbar.

## Edit a preset in the preset editor

1. With existing presets for the canvas, select Show presets.

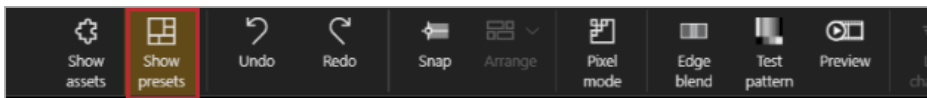

2. From Presets, find the preset you want to edit and select .
3. A red bar indicates the preset is being edited.

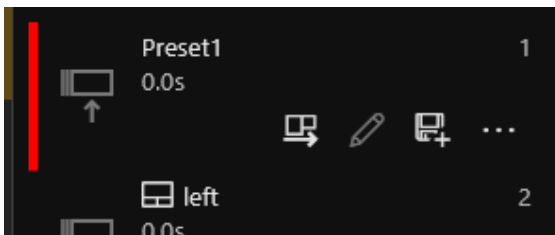

Preset and window input events won't update the windows while you are editing your preset.

4. Select or clear which windows you want to include in your preset.

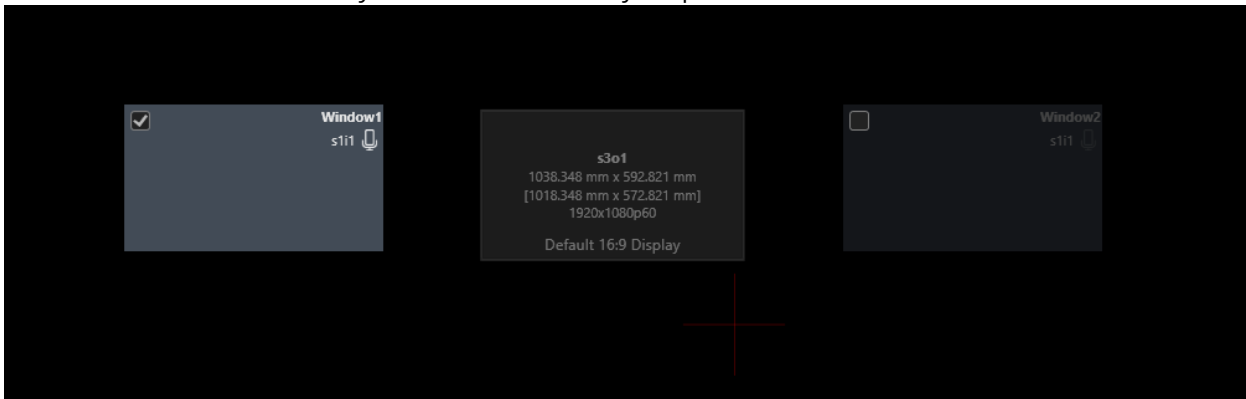

5. Update the included windows for the preset, for example change their position, rotation, border color, or change which windows are included in the preset.

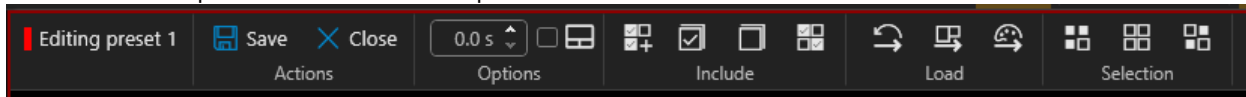

6. You can use the preset editor toolbar to perform various actions.



- Actions: Save your preset or close the preset editor.
- Options: Change the duration or Layout only.
- Include: Tools to help you include or exclude windows in your preset.

✔ You can select windows, then use the Include tool  to include them in the preset.

- Load: Revert or load the preset editor windows with values from other places.

✔ You can also load any preset values into the preset editor without changing the currently loaded preset on your device from  Presets > find the preset to load > select .

- Selection: Tools to help you select windows in the preset editor.

7. Select  Save from the preset editor toolbar.

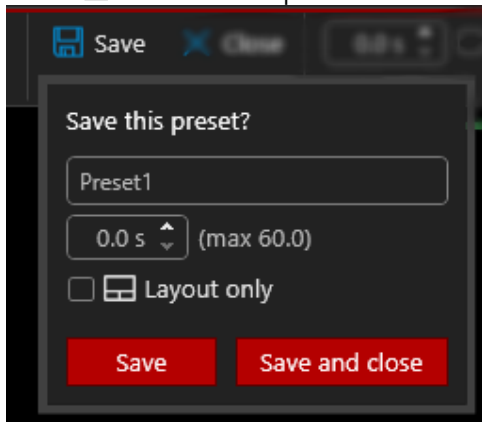

8. OPTIONAL: You can change the preset options, for example name, duration, or layout only.

9. Select Save or Save and close.

## Previewing changes on the device while editing a preset

1. With existing presets for the canvas, select  Show presets.

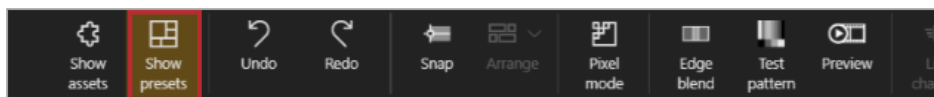

2. From  Presets, find the preset you want to edit and select .

When editing a preset  Live changes is turned off so you can make changes to the preset without affecting the live window values on the device.

3. You can turn  Live changes back on to see your updates in real-time on the device.

or

4. You can select  Take to send all changes to the device.

✔ You will need save any changes and close the preset editor to test your preset transitions in context with your other presets .  
Read more about loading presets on page 73.



## Quick edit, overwrite, cloning, and deleting presets

You can change the name and duration of a preset, or overwrite a preset with a new configuration.

### To quickly change the name or duration of a preset

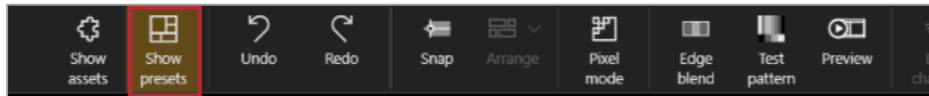
1. Select  Show presets.





2. In  Presets, find the preset you want to edit, select  and select .
3. Enter a new name or duration.

### To overwrite a preset

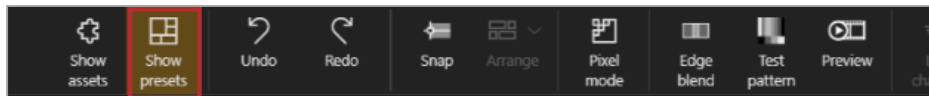
1. Create the new arrangement on your canvas and select  Show presets.



2. In  Presets, find the preset you want to overwrite and select .



 Overwriting a preset is similar to creating a new preset.

 If you want to keep the existing preset windows select Choose windows.

### To clone a preset

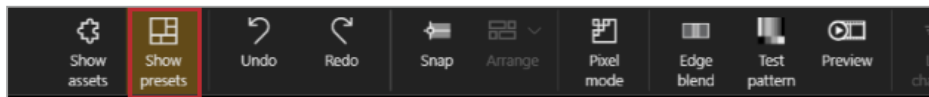
1. Select  Show presets.





2. In  Presets, find the preset you want to clone, select  and select .
- A new preset is added to the end of the list.

### To delete a preset

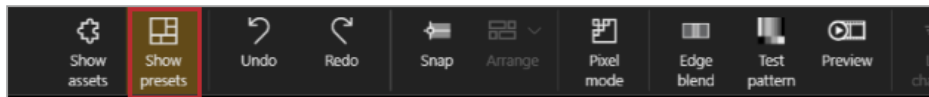
1. Select  Show presets.



2. In  Presets, find the preset you want to delete, select  and select .

## Loading a preset

If you have saved one or more presets in CORIOgrapher™, then you can choose a preset to load. You can choose presets in CORIOgrapher, and if you have a CORIOmaster micro™, you can use the buttons to choose from a selection of presets.

### What is a preset?

A preset stores information about windows, including positions, transitions, and effects such as borders or rotation. You can save presets and recall them later from the dashboard, or using the buttons of your CORIOmaster micro.



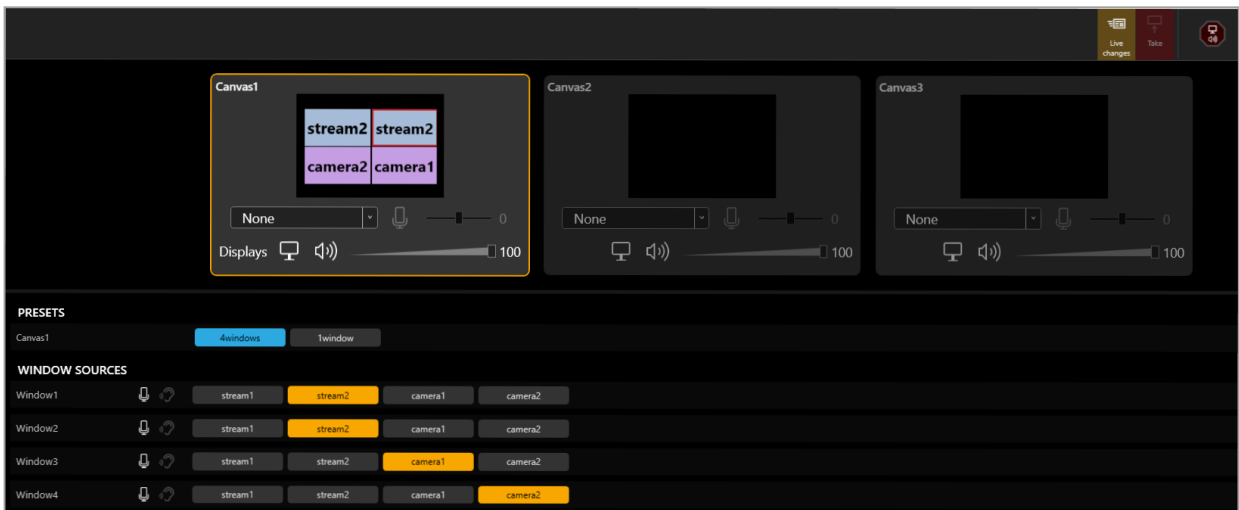

## Loading a preset from CORIOgrapher

You can load any of your saved presets in CORIOgrapher from  Dashboard or  Editor.

- From  Dashboard, select a preset.



Or

- From  Editor, select  Show presets. In  Presets, find the preset you want to show, select .
- The yellow bar indicates the last loaded preset.

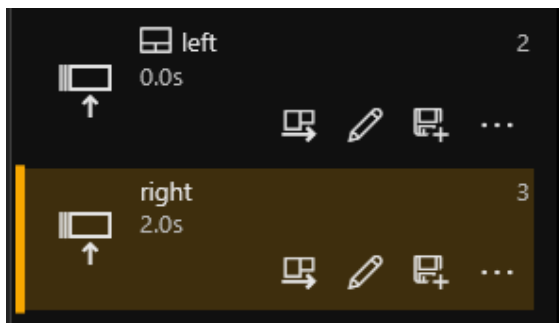

## Loading a preset with the buttons of your CORIOmaster micro

You can choose from eight presets with the buttons of your CORIOmaster micro. By default, the eight buttons correspond to saved presets 1 to 8. You can configure your buttons to correspond to your choice of presets.

Read about configuring the buttons of your CORIOmaster micro on page 51.

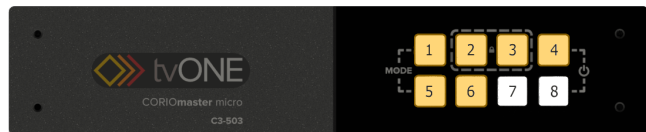

When your CORIOmaster micro is in preset selection mode, the buttons are orange. Any buttons that do not have a corresponding preset are unlit.

1. Check that your CORIOmaster micro is in the correct mode for choosing presets.  
If your CORIOmaster micro is not in the correct mode, press and hold buttons 1 and 5.
2. Press and release the button that corresponds to your chosen preset.  
The button flashes while the preset loads, and is then brightly lit.

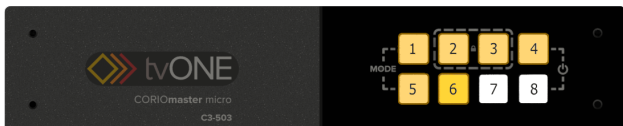

Note: while a preset is loading and the button is flashing, you cannot select another preset. Wait until the button stops flashing.



## Show me some preset scenarios

You can use presets to create installations for various scenarios, from simple to sophisticated. Using the presets correctly can dramatically reduce the number you will need to achieve your desired results.

### All the windows presets

All the windows presets are great for resetting the canvas to a known state, for example at the start of the day, event, or meeting. You can put all the windows and source selections back to something you know is good to use.



### Layout only presets

Presets can be created that do not change the source selection of windows. This can be used when you want to change the layout of the windows, but keep your window sources as you have set them.



You can change the window source for specific windows from CORIOgrapher or with a third-party controller using the API.

### Control different aspects of the same area on the canvas

You can control different groups of windows in your installation on the same canvas, for example you have a main presenter display and 2 side displays, you can create presets that only change the windows you want.



### Zone your canvas

If using different canvases is not possible then you can extend the concept of controlling different areas to zoning your canvas.

#### Recommendations when naming presets:

- ✓ Create prefixes for the different zones, for example Room\_1\_ and Room\_2\_.
- ✓ Prefix your displays with the same zone as your presets to help organize the canvas, for example Room\_1\_LED\_1.
- ✓ Have a 'reset all' preset that puts the whole canvas back to a known good state, for example 'Default Start Up'.
- ✓ Have a 'reset zone' preset for example Room\_1\_Reset or Room\_1\_Default.
- ✓ Leave enough space between the zones for window transitions on and off the displays.
- ✓ Third-party controllers can use the prefix to filter by zone, so you only see the presets you are interested in.

## Space is important

✗ Zones are too close together

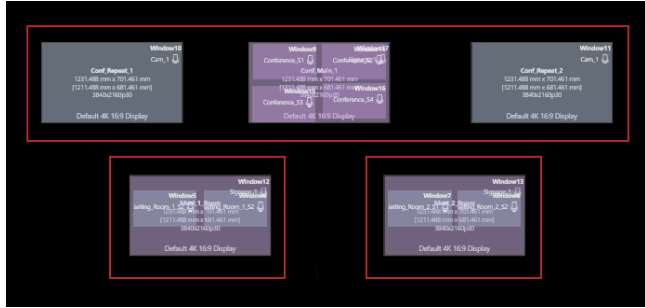

✓ Zones have enough space to move windows around the displays

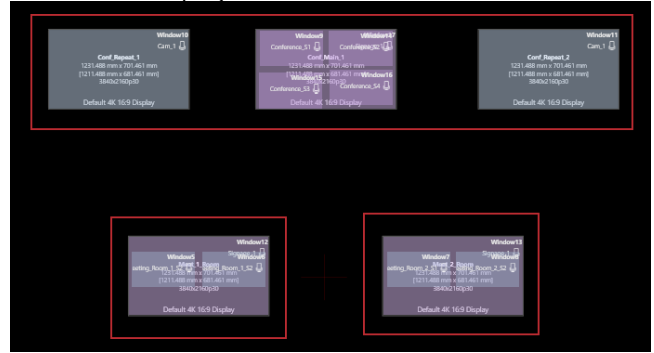

## Adding more windows with existing presets.

If you are adding new windows after you have created presets then existing presets will not know about the new windows. When you load a preset these windows will not update, if this is undesirable behavior you can include them in your presets.

You can use the preset window analyzer to help identify presets and windows that need your attention.

### Enabling or disabling the preset window analyzer

1. From Editor, select Show presets. In Presets, select to enable or disable the analyzer.



2. If you have windows missing from presets then a dialog will give you instructions on what you can do.
3. Check each canvas and look for on presets and windows to indicate what needs your attention.



You can disable the preset window analyzer when you have finished.

The analyzer is disabled each time you load or read a device configuration.

### Manually updating presets with the new windows

1. From Editor, select Show presets.

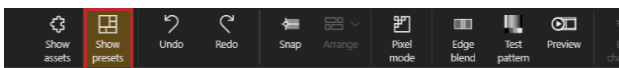



2. In Presets, select to enable the analyzer.

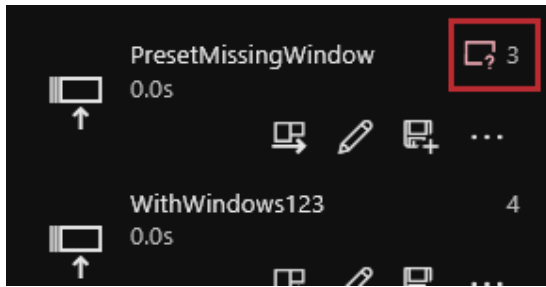

3. In Presets, choose a preset to update by looking for .





4. Select  to edit the preset. This will load the preset into the preset editor without changing the currently loaded preset on your device.
5. Include and reposition your windows.
6. Select  Save from the preset editor toolbar.



Read more about editing presets on page 66.

## Bulk updating presets

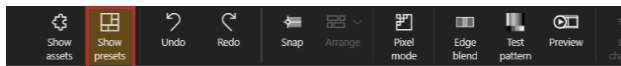

 Do not bulk update presets if you are deliberately using selected windows in your presets.

1. From  Editor, select  Show presets.



2. In  Presets, select  to enable the analyzer.



3. In  Presets, select  to bulk update the canvas presets.

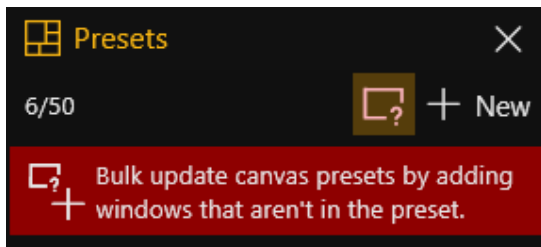

4. We will automatically add the windows that are not in the presets in their current location.

 You can do a mixture of manually updating some presets, and bulk updating the rest.

## Changing the source playing in a free window

You can choose which source plays in any free window in CORIOgrapher™. If you have a CORIOmaster micro™, you can change the source with the buttons of the front panel. The color of free windows depends on the quality of the window.

### Changing the source in CORIOgrapher from the Properties panel

1. From ☺ Editor, double-click the free window you want to change.
2. From Properties, choose a source from Input Slot.

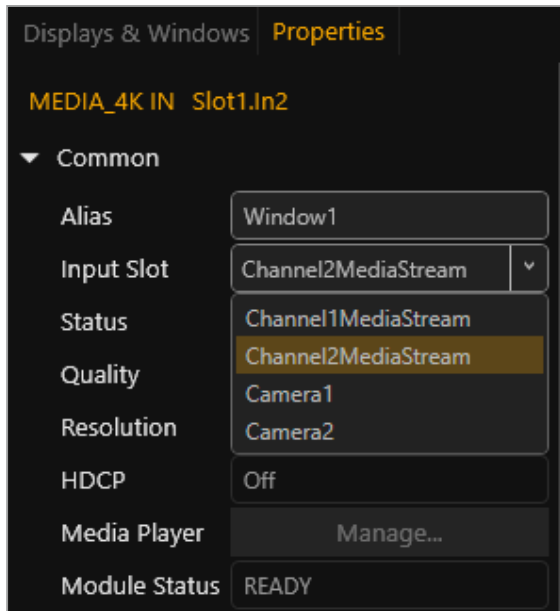

### Changing the source in CORIOgrapher from the window

1. From ☺ Editor, select the free window you want to change.
2. Select ⋮, choose a source from list.

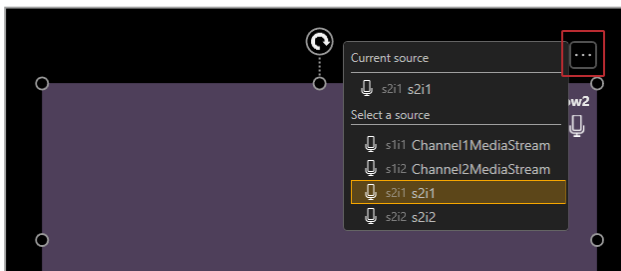

✓ You can mute and unmute a source's audio by selecting the microphone next to the source.

### Changing the source with the buttons of your CORIOmaster micro

You can choose from up to eight sources with the buttons of your CORIOmaster micro. By default, the eight buttons correspond to your first eight sources. You can configure your buttons to correspond to your choice of sources.

Read about configuring the buttons of your CORIOmaster micro on page 51.

When your CORIOmaster micro is in source selection mode, the buttons are green. Any buttons that do not have a corresponding source are unlit.

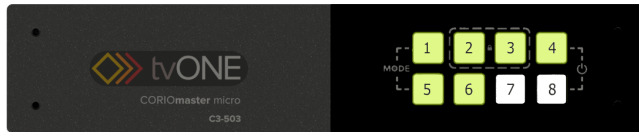

1. Check that your CORIOmaster micro is in the correct mode for choosing sources.  
If your CORIOmaster micro is not in the correct mode, press and hold buttons 1 and 5.
2. Press and hold the button that corresponds to the window that you want to change, until it starts flashing.  
Note: if you are listening to audio, when you choose a window, you hear the audio from that window. You can change the audio back to your chosen window at the end of this task.
3. Press and release the button that corresponds to your chosen source.  
The button flashes, and is then lit more brightly.

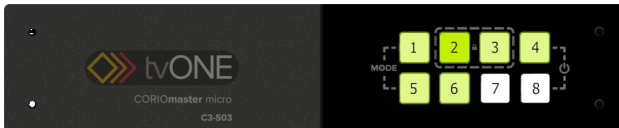

4. Optional: change the audio source back to your previous source. Press and hold the button that corresponds to the window that you want to hear, until it starts flashing.

## Changing the source using the dashboard

You can change the source playing in any free window from the dashboard in CORIOgrapher.

1. From  Dashboard, find the free window you want to change, and select a source.

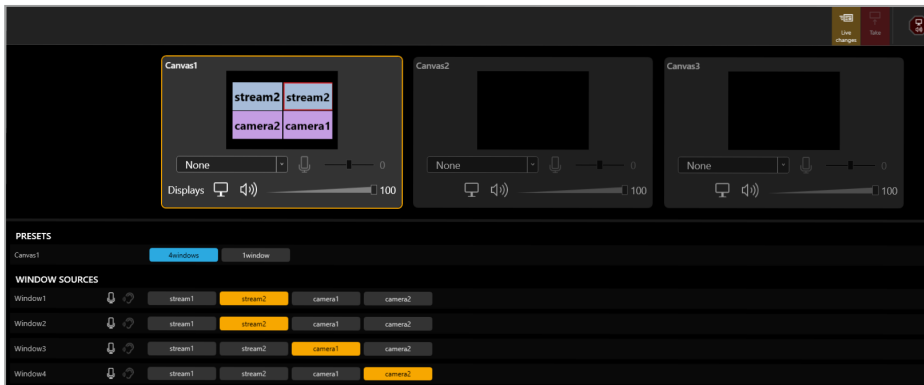

2. Select  Take.

## Using audio

All CORIOmaster™ devices support embedded audio. CORIOmaster micro™ also includes an independent S/PDIF output.

Read about setting up and testing your audio on page 43.

### In this section

Playing embedded audio .....	81
Playing independent audio with a CORIOmaster micro™ .....	94

## Playing embedded audio

You can play embedded audio on any CORIOmaster™ device. There are two modes, breakaway audio mode, and audio-follows-video mode.

Read about setting up and testing your audio on page 43.

Audio is not saved as part of a preset.

 Audio settings are set for sources, not windows. If you adjust or mute the audio from a window, all the windows playing that source are affected.

### In this article

About embedded audio .....	82
Disabling and enabling audio for a source or display .....	82
Choosing what to listen to with CORIOgrapher .....	85
What's breakaway audio? .....	85
Choosing which outputs play audio .....	87
Adjusting input audio level and muting sources .....	87
Muting individual audio outputs .....	89
Cutting to black and muting individual outputs .....	89
Adjusting volume and muting all displays and outputs associated with a canvas .....	90
Cutting to black and muting all displays and outputs associated with a canvas .....	91
Controlling audio from the dashboard .....	92
Emergency cut to black and mute .....	92

## About embedded audio

- You can play embedded audio from any input port on any input module, as long as the embedded audio is in uncompressed PCM format, at 48 kHz.
- You can play embedded audio, and audio from the S/PDIF and analog audio module, on any output device associated with your video wall.
- CORIOmaster supports 2-channel audio, and does not support surround sound.
- You can only play audio from the S/PDIF and analog audio module in breakaway audio mode.
- The CORIOmaster micro also has an independent S/PDIF audio output that you can connect to a digital audio device with an RCA cable.

Read more about playing audio with the S/PDIF output on page 94.

## Disabling and enabling audio for a source or display

If you never want to hear a source, or you never want to play audio on a specific display, you can disable it.

Administrators can disable audio from ⚙ Settings > Slot Status.

Administrators and power users can disable audio from 😊 Editor > Properties.

❗ Users cannot re-enable the audio, so if you want other users to be able to restore audio, mute the source or display instead.

When the audio from a source is disabled, it is not available to select from the wall editor or the dashboard. When the audio to a display is disabled, the button to mute and unmute audio on that display is not available from Displays & Windows.

## Disabling and enabling audio from Slot Status

Administrators can disable and enable sources and outputs.

1. Select ⚙ Settings > Slot Status.
2. Select or clear Audio Enabled.

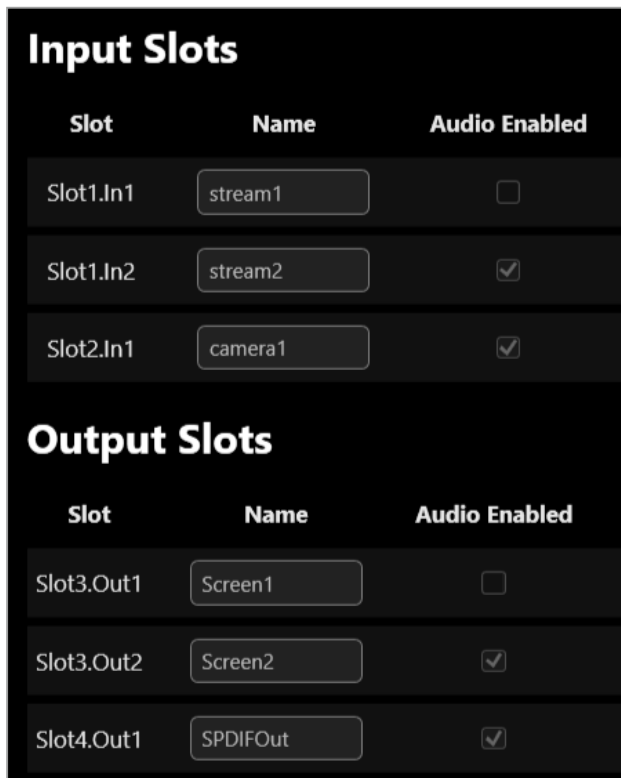

Input Slots		
Slot	Name	Audio Enabled
Slot1.In1	stream1	<input type="checkbox"/>
Slot1.In2	stream2	<input checked="" type="checkbox"/>
Slot2.In1	camera1	<input checked="" type="checkbox"/>

  

Output Slots		
Slot	Name	Audio Enabled
Slot3.Out1	Screen1	<input type="checkbox"/>
Slot3.Out2	Screen2	<input checked="" type="checkbox"/>
Slot4.Out1	SPDIFOut	<input checked="" type="checkbox"/>



## Disabling and enabling an audio source playing in a window from Properties

Administrators and power users can disable audio sources.

1. From  Editor, select a window.

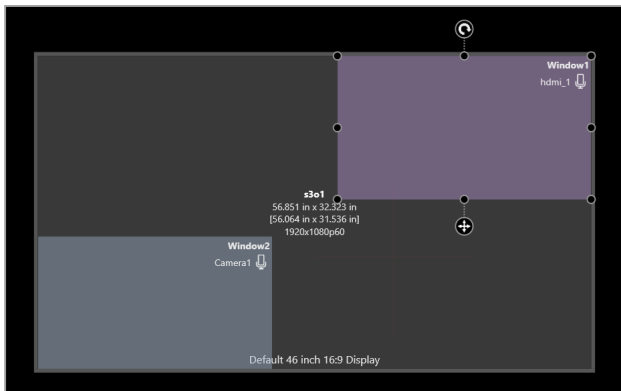

2. Select Properties > Input Settings (shared).
3. Select or clear Audio Enabled.

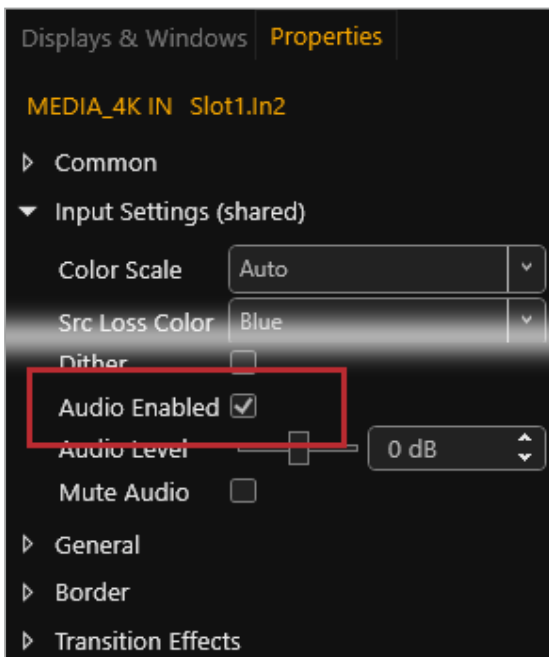

## Disabling and enabling audio for a display from Properties

Administrators and power users can disable audio for displays.

1. From  Editor, select a display.

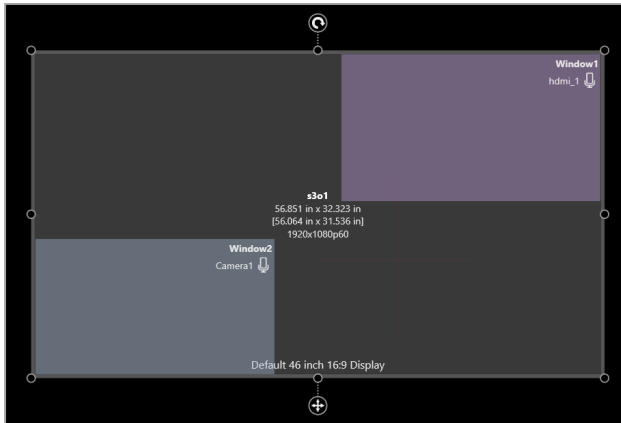

2. Select Properties > Audio.
3. Select or clear Audio Enabled.

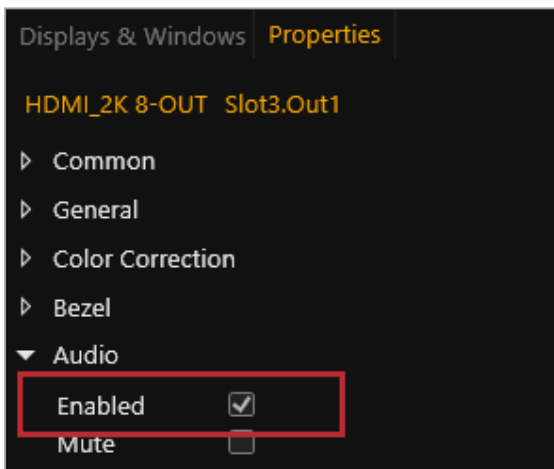

## Choosing what to listen to with CORIOgrapher

All users can choose what embedded audio to listen to.

### Choosing a source to listen to with breakaway audio mode

#### What's breakaway audio?

Breakaway audio is independent of the windows on your video wall. It doesn't change when the sources playing in your windows change. The audio is sent to all enabled outputs.

When you choose breakaway audio mode, you hear your chosen audio all the time, even if your video sources change.

- From  Editor, select a source from the list.

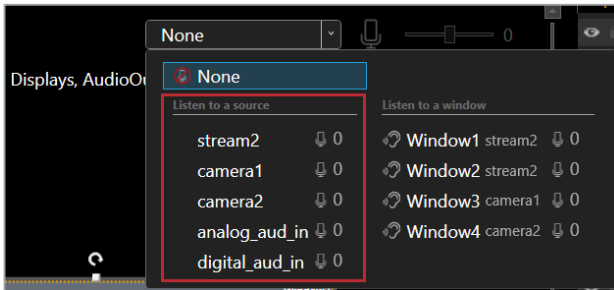

Or

- From  Dashboard, select a source from the list.

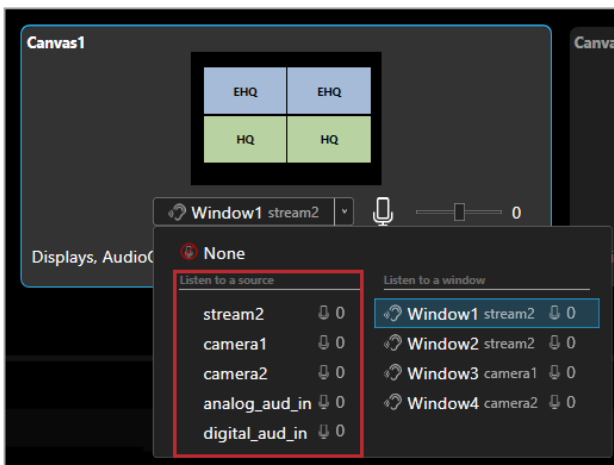

## Choosing a window to listen to with audio-follows-video mode

When you choose audio-follows-video mode, you listen to a window. If the source playing in that window changes, the audio changes to play the new source.

- From  Editor, select a window from the list.

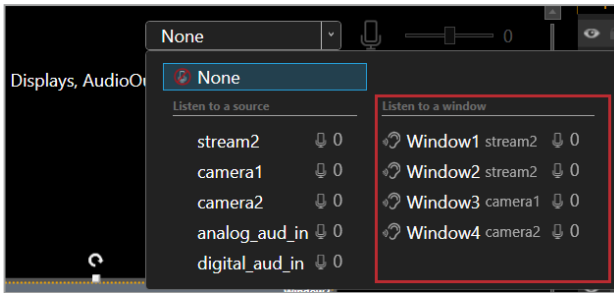

Or

- From  Dashboard, select a window from the list.

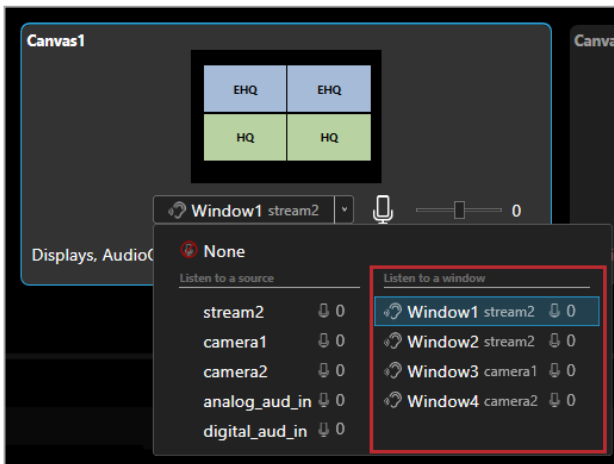

## Choosing which outputs play audio

Audio from any source is sent to all the displays associated with a canvas. If you have an S/PDIF and analog audio module, the audio is also sent to the output associated with the canvas.

Read more about the S/PDIF and analog audio module on page 22.

You can see where audio is sent from  Editor:

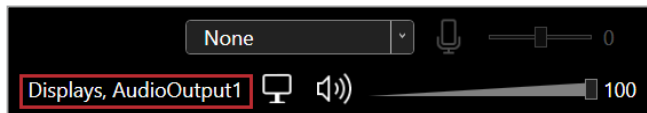

And from  Dashboard:

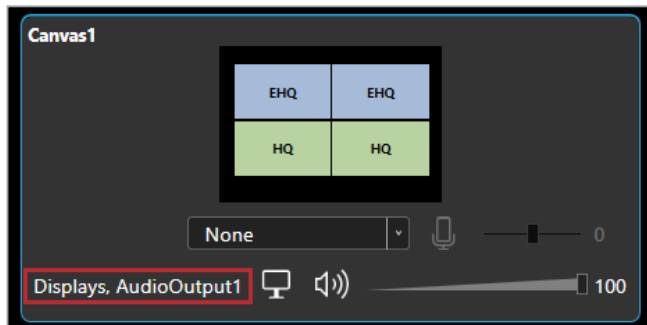

Audio is not sent automatically to the S/PDIF output of a CORIOmaster micro.

Read about sending audio to the S/PDIF output of a CORIOmaster micro on page 94.

You can choose to only send audio to one or more specific outputs by disabling or muting the other outputs.

Read about disabling outputs on page 82.

Read about muting outputs on page 89.

## Adjusting input audio level and muting sources

All users can mute, unmute, and adjust the input audio level for any source.

Adjust the input audio level to match and balance the audio levels of different sources. For example, if you have one very loud source, lower the input audio level until it matches your other sources.

## To mute and unmute a source

1. Select a source.

From  Editor:

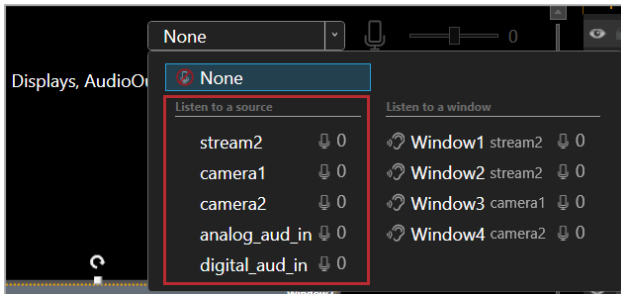

From  Dashboard:

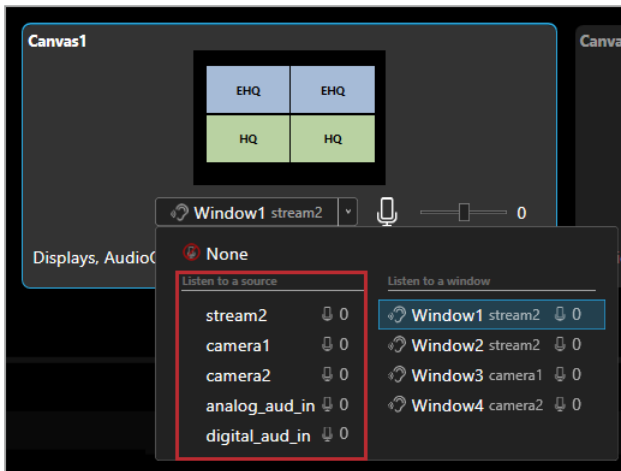

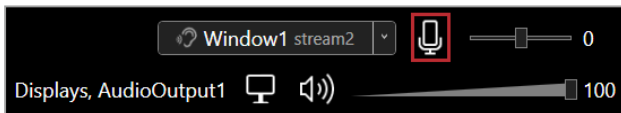

2. Mute or unmute the source.

From  Editor:

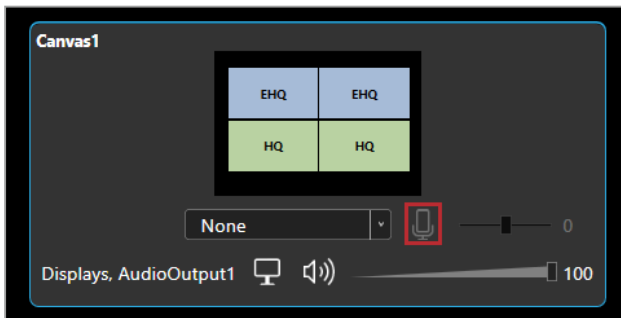

From  Dashboard:



- To mute audio, select .
- To unmute audio, select .

## To adjust the input audio level for a source

1. Select a source.

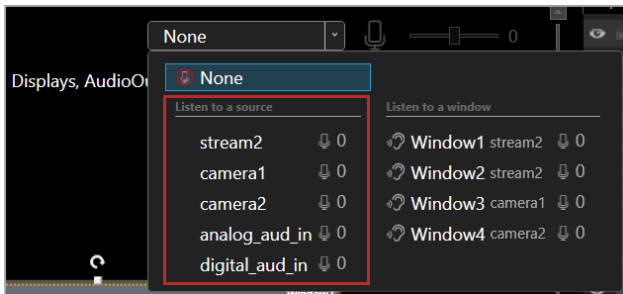

2. Adjust the input audio level.

From Editor:

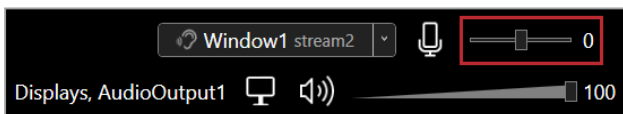

From Dashboard:

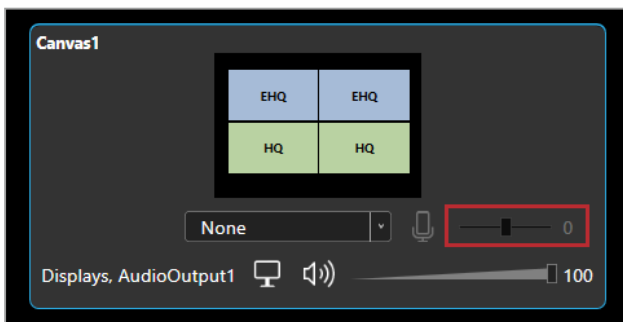

- Slide to the right to increase audio input.
- Slide to the left to reduce audio input.

## Muting individual audio outputs

Administrators and power users can mute and unmute individual outputs.

From Editor > Displays & Windows:

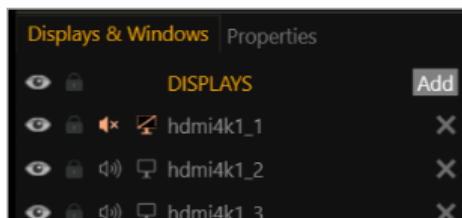

- To mute audio, select .
- To unmute audio, select .

Outputs that do not show or are disabled in Settings > Slot Status.



Outputs that show are cut to black and muted, or the canvas is muted.

## Cutting to black and muting individual outputs

Administrators and power users can cut to black and mute individual outputs, and restore them.

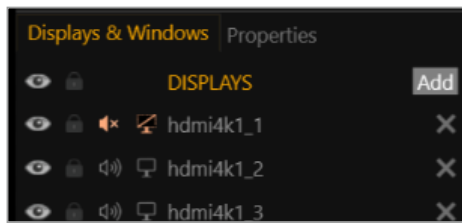
From  Editor > Displays & Windows:



- To cut a display to black and mute, select .
- To restore a display, select .

## Adjusting volume and muting all displays and outputs associated with a canvas

All users can mute, unmute, and adjust the volume for all displays and outputs associated with a canvas at the same time in CORIOgrapher.

 This does not affect the S/PDIF output of the CORIOmaster micro.

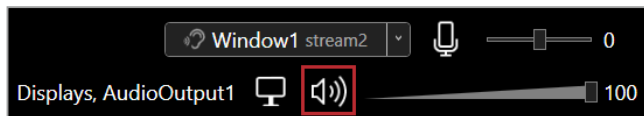

## To mute and unmute all displays and outputs associated with a canvas

From  Editor:

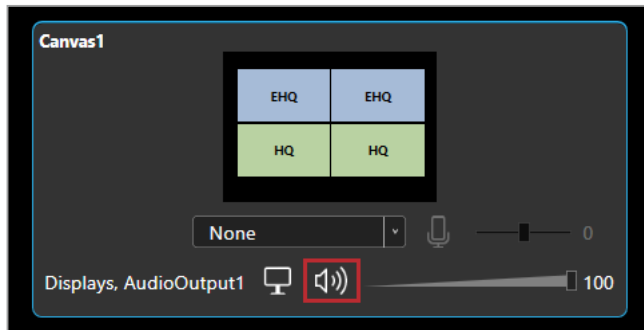

From  Dashboard:



- To mute audio, select .
- To unmute audio, select .



## To adjust the volume for all displays and outputs associated with a canvas

From  Editor:

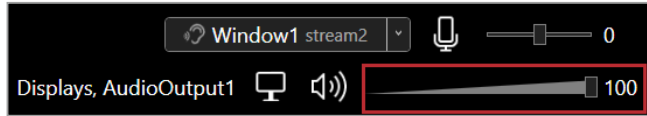

From  Dashboard:

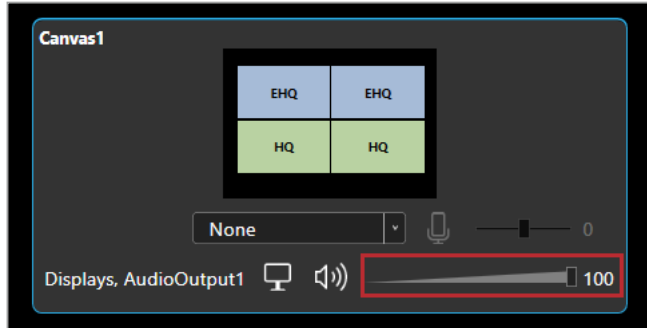

- Slide to the right to increase volume
- Slide to the left to reduce volume

## Cutting to black and muting all displays and outputs associated with a canvas

All users can cut to black and mute, and restore, all displays and outputs associated with a canvas at the same time in CORIOgrapher.

 This does not affect the S/PDIF output of the CORIOmaster micro.

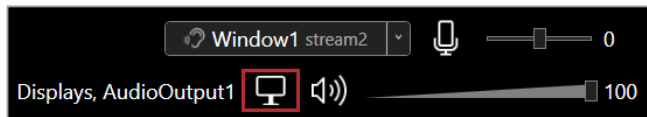

## To cut to black and mute all displays and outputs associated with a canvas

From  Editor:

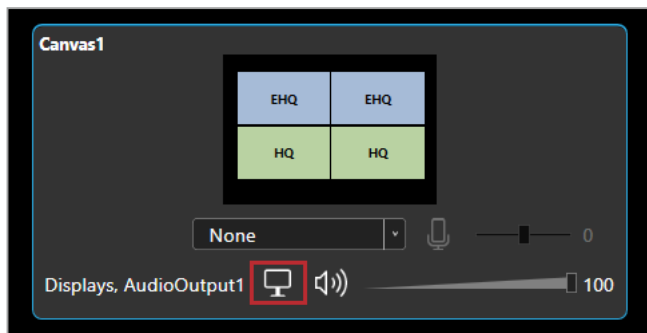

From  Dashboard:



- To cut to black and mute all displays and outputs associated with the canvas, select .
- To restore all displays and outputs associated with the canvas, select .

## Controlling audio from the dashboard

All users can choose what to listen to, mute and unmute specific sources and the current source, mute all displays and outputs, and adjust the input audio level and volume.

 This does not affect the S/PDIF output of the CORIOmaster micro

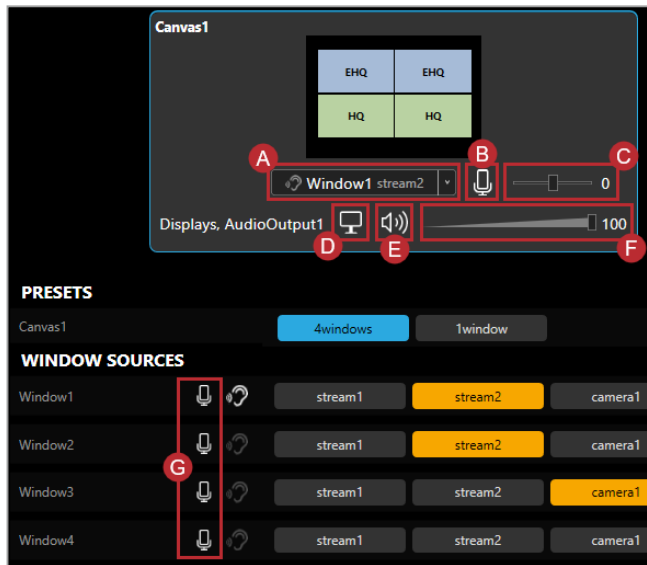

- A** Select a source or window to listen to.

---

- B** Mute and unmute the source currently playing.

---

- C** Adjust the input audio level of the source currently playing.

---

- D** Cut to black and mute all displays and outputs, and restore all displays and outputs.

---

- E** Mute and unmute all displays and outputs.

---

- F** Adjust the volume of all outputs.



---

- G** Mute the sources playing in specific windows.

## Emergency cut to black and mute

All users can cut to black and mute, and restore, all displays and outputs across all canvases, including the S/PDIF output of the CORIOmaster micro in CORIOgrapher >  Dashboard.

### To cut to black and mute all displays and outputs

- To cut to black and mute all displays and outputs, select .
- To restore all displays and outputs, select .



# Playing independent audio with a CORIOmaster micro™

Your CORIOmaster micro can play independent audio. Connect the S/PDIF port of your CORIOmaster micro to a digital audio device, with an RCA cable. You can control what you hear from the S/PDIF output with the buttons of the front panel.

**!** Embedded audio and independent audio can play at the same time.

Your CORIOmaster micro can also play embedded audio. Control embedded audio with CORIOgrapher. Read about playing embedded audio on page 81.

**!** Audio settings are set for sources, not windows. If you adjust or mute the audio from a window, all the windows playing that source are affected.

## In this article

About independent audio .....	94
Choosing which window to hear with the buttons of the front panel ...	95
Show me an example .....	95
Choosing which window to hear with CORIOgrapher .....	96
Adjusting the input audio level and muting individual sources .....	96
Muting the audio output .....	97

## About independent audio

- Your CORIOmaster micro has an S/PDIF audio output that you can connect to a digital audio device with an RCA cable.
- You can listen to a source playing in a window. The window you hear is the active window. You can choose which window is active with the buttons of the front panel. In CORIOgrapher > Editor, the active window shows .
- You can mute and adjust the input audio level of individual sources playing in windows in CORIOgrapher™.

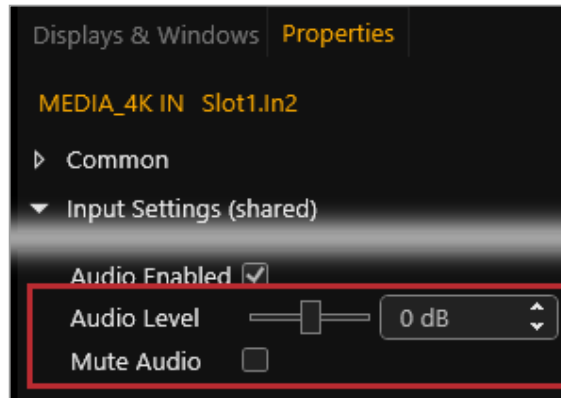

- You can mute the audio output in CORIOgrapher.

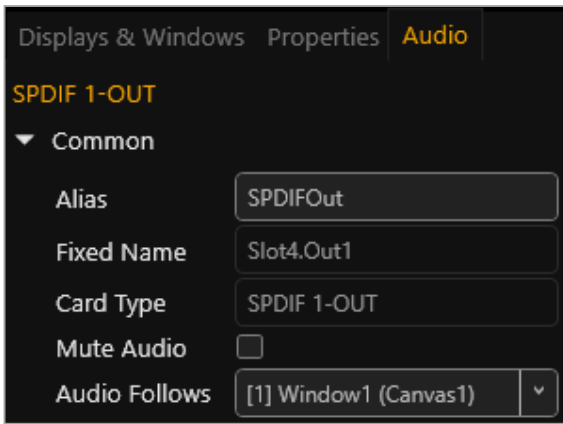

- The Streaming media and 4K playback input module only supports the following embedded audio formats:
  - mp3
  - aac

### Choosing which window to hear with the buttons of the front panel

You can choose which window to hear with the buttons on your CORIOmaster micro. By default, the eight buttons correspond to your first eight sources. You can configure your buttons to correspond with your choice of windows.

You can choose to hear any window, including windows that aren't showing on your video wall, or are on a different canvas.

#### Show me an example

In this example, window 3 is not showing on the video wall, but you can still choose to hear the audio from window 3. Note that window 3 is a preview window to reduce video bandwidth.

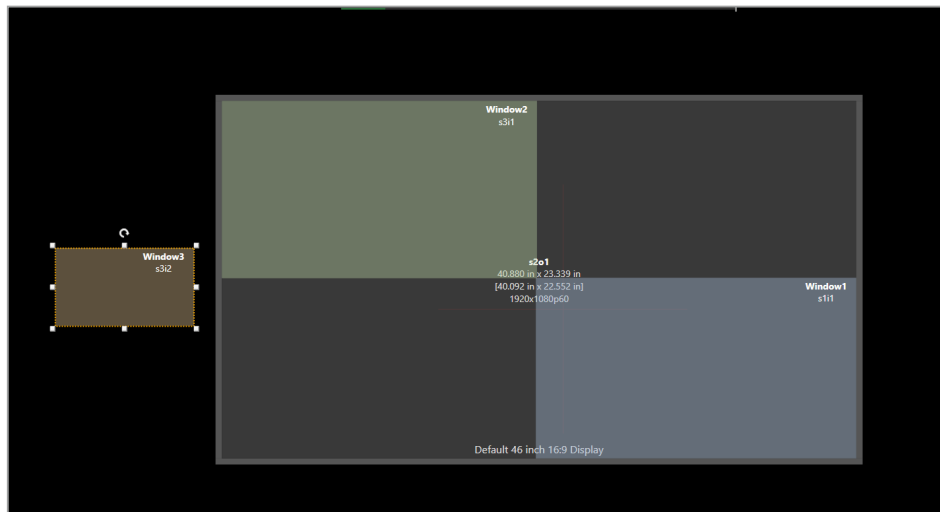

- Press and hold the button that corresponds to the window you want to hear, until it flashes red.

## Choosing which window to hear with CORIOgrapher

You can choose which window to hear in CORIOgrapher.

1. From the wall editor, select Audio.
2. Select a window to hear from Audio Follows.



## Adjusting the input audio level and muting individual sources

For each source, you can mute, unmute, and adjust the input audio level in CORIOgrapher.



Audio settings are set for sources, not windows. If you adjust or mute the audio from a window, all the windows playing that source are affected.

## Adjusting input audio level and muting using source properties

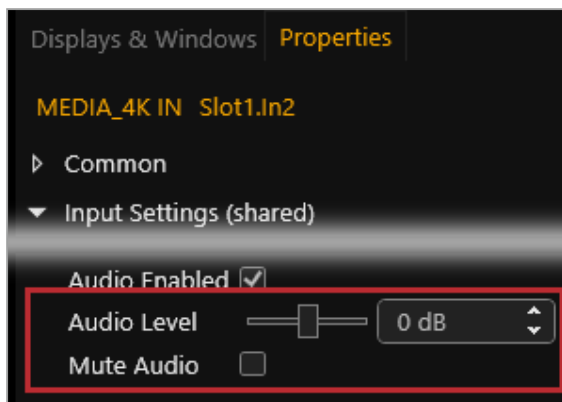

1. Double-click any window playing the source you want to adjust.
2. In Properties, adjust the audio.
  - Use the Audio Level slider to set input audio level.
  - To mute the audio, select Mute Audio.
  - To restore audio, clear Mute Audio.



## Muting sources from the wall editor

On the wall editor, you can mute and unmute the sources associated with the windows of your video wall.



- To mute audio, select .
- To unmute audio, select .

## Muting the audio output

You can mute and unmute the S/PDIF audio output in CORIOgrapher.

## Muting using audio properties



- From the wall editor, select **Audio > Mute Audio**.

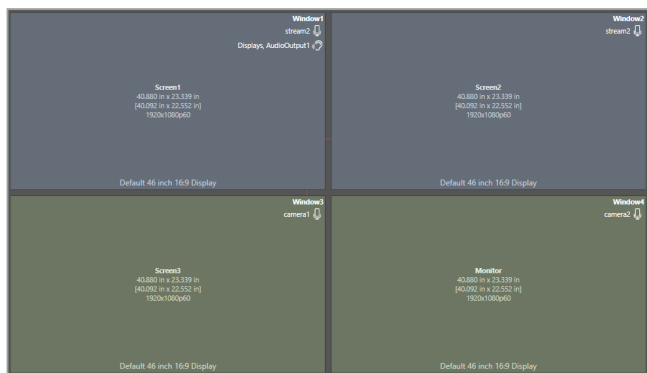

## Muting the audio output from the wall editor

On the wall editor, the window playing audio shows .



- To mute the audio output, select .
- To hear the audio output, select .

## Media and streams

If you have a Streaming media and 4K playback input module, you can play media items and streams.

### In this section

Playing media and streams .....	98
Creating and managing playlists .....	109
Using the internal drive .....	116
Choosing the best resolution for your playlist or play queue .....	119

## Playing media and streams

If you have a Streaming media and 4K playback input module, you can play media items and video streams. Add up to 40 media items or streams to a play queue or saved playlist. Each Streaming media and 4K playback input module has two channels. Each channel has its own play queue.

### In this article

Before you start .....	99
Adding and editing media streams .....	99
Adding media items, streams, and playlists to your play queue .....	101
Playing a multicast stream from an Magenta Encoder-100 on multiple CORIOmaster units .....	102
Changing the duration of media items .....	103
Playing streams with low latency .....	104
Using the playback controls .....	105
Managing the play queue .....	106
Saving the play queue .....	107
Show labels for media and streams .....	107
Playing the play queue automatically .....	107
Saving media to internal storage .....	108

Manage your media and streams in CORIOgrapher™. Double-click the window you wish to play media or streams, and select (Media Player) Manage.

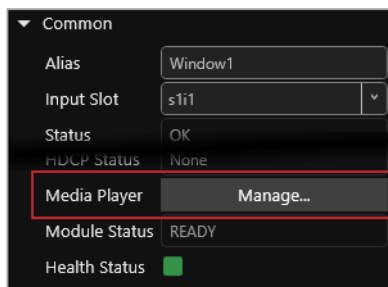

! The media player is not available when you work offline.



Streaming media and 4K playback input modules in CORIOmaster™ units support embedded audio, for streams and media items with the following embedded audio formats:

- mp3
- aac

! CORIOmaster automatically mutes audio from streams with low latency.

Read more about playing audio with your CORIOmaster on page 81.

Read more about playing audio with your CORIOmaster micro™ on page 94.

## Before you start

- To stream media from the internet or your network, you need to connect an Ethernet cable and configure the network settings for your Streaming media and 4K playback input module.



✓ For best results, use Gigabit equipment and cables.

Read about configuring network settings for a Streaming media and 4K playback input module on page 56.

- To turn any video source into a stream, you need an encoder. The encoder takes video and audio signals, converts them to an AVIP (Audio-Visual over Internet Protocol) signal, and sends them over your network. For example, you could encode and stream the signal from an endoscope, or from a camera in a lecture theater.

Read about the Magenta Encoder-100 on page 23.

- To play media directly from a USB drive, or copy media from a USB drive to internal storage, you need to connect a USB drive to your Streaming media and 4K playback input module.

✓ Use a good quality, high-speed USB 3.0 drive.

- To play media saved in the internal storage of the Streaming media and 4K playback input module, you don't need to connect anything.
- To play any kind of media you need to set up a video installation with a window playing a channel from your Streaming media and 4K playback input module.

Read about setting up a basic video wall on page 39.

## Adding and editing media streams

You can manually add media streams from your network or from the internet. You can configure and add streams from an Magenta Encoder-100.

Read about configuring your Magenta Encoder-100 at [help.tvone.com/r/docs/cm/encoder-100/1](http://help.tvone.com/r/docs/cm/encoder-100/1).

## To manually add a stream

If you know the URL of the stream, and the stream is not hosted by an Magenta Encoder-100, use this method.

1. In  Editor, double-click the window you wish to play streaming media, and select (Media Player) Manage.

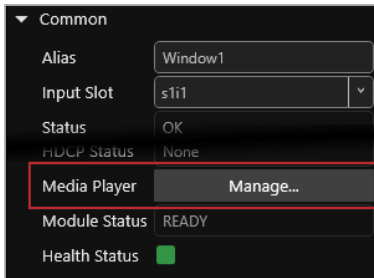

2. Select IP Streams.

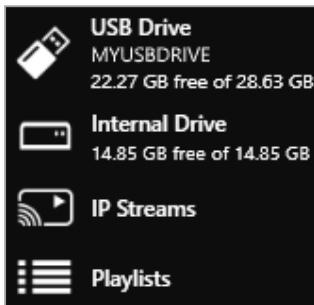

3. Select Add IP Stream.
4. Enter a descriptive name and the URL of the media stream, and then select Add IP Stream.
5. To edit the details of a media stream, select the stream and then select  > Edit.
6. Edit the name or URL of the media stream.

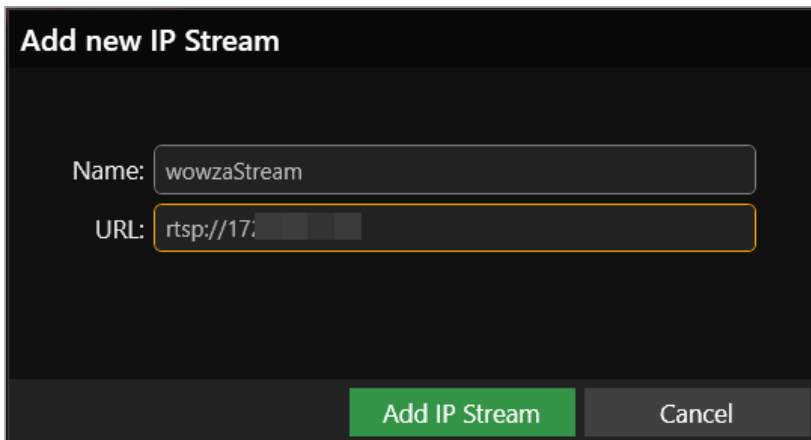

The screenshot shows the 'Add new IP Stream' dialog box. The 'Name' field contains 'wowzaStream' and the 'URL' field contains 'rtsp://17.'. The 'Add IP Stream' button is highlighted in green, and the 'Cancel' button is visible.

## Previewing the stream from your Magenta Encoder-100

If you have an Magenta Encoder-100 that is streaming, you can preview the stream.

- Select the Magenta Encoder-100, and then select **⋮** > Preview.

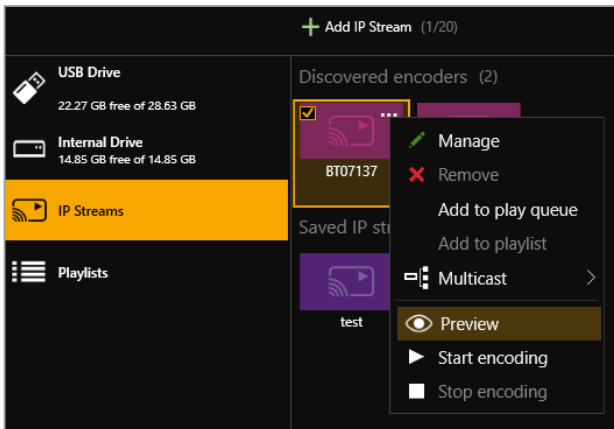

## Adding media items, streams, and playlists to your play queue

You can add video clips, still images, and media streams to a play queue, up to a total of 20 items. Media items can be on a USB drive, in internal storage, streamed from your network, or streamed from the internet.

You can also add a playlist to a play queue. When you add a playlist to a play queue, the playlist replaces all the items in the play queue.

You add all types of media, streams, and playlists the same way, when the play queue is playing, paused, or stopped.

You can play audio embedded in video clips and media streams. You cannot play audio-only files.

1. In **Ⓜ** Editor, double-click the window you wish to play streaming media, and select (Media Player) Manage.

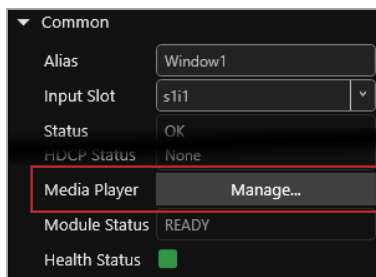

2. Select your media source.



3. Drag media items and streams, or a playlist, into the play queue.



Still image



Saved stream



Video clip



Found encoder



Playlist



Found encoder, streaming

4. Choose a resolution for your play queue.

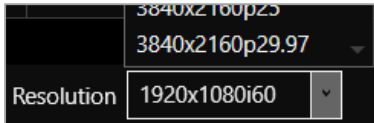

Read about choosing the right resolution on page 119.

Read more about playlists on page 109.

### Playing a multicast stream from an Magenta Encoder-100 on multiple CORIOmaster units

By default, your Magenta Encoder-100 supplies a single stream to a single CORIOmaster. You can supply a multicast version of that stream to more than one CORIOmaster.

### Adding a multicast stream from an Magenta Encoder-100 to a play queue or playlist

- You don't need to configure your Magenta Encoder-100 to send a multicast stream, if your default address and TTL are correct for your network.  
For more help, contact your network administrator.
- To add a multicast stream to the play queue, the play queue must be stopped.
- To add a multicast stream to a playlist, first select a playlist.

1. Select IP Streams.
2. Select the Magenta Encoder-100 you want to add.
3. Select **⋮** > Multicast > Add to play queue or Add to playlist.

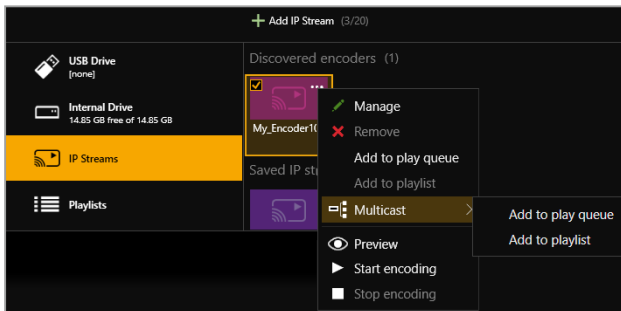

## Changing a single stream to a multicast stream

If you already added a single stream from an Magenta Encoder-100 to the play queue or a playlist, you can change the single stream to a multicast stream.

1. If the encoder is in a playlist, open the playlist.
2. Select the encoder, and select **•••** > Edit.
3. Select RTSP Multicast.

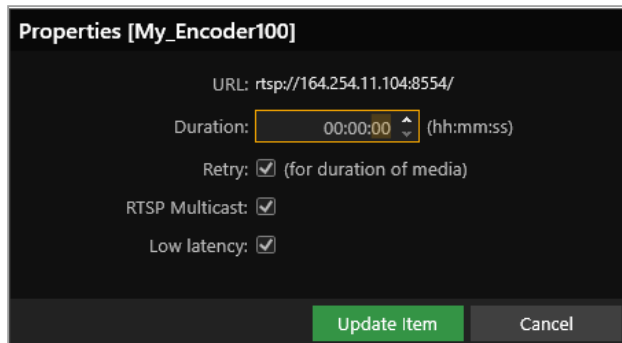

## For best results

If you send a multicast stream on a large network, tvONE™ recommends using equipment with IPv4 multicast addressing, and/or IGMP v2 support. For more information, contact your network administrator.

## Changing the duration of media items

By default, still images play for 10 seconds, video clips play for the length of the clip, and streams play indefinitely, until the stream ends.

You can choose how long to play each media stream, video clip, or still image in the play queue.

1. In the play queue, select the media item.
2. Select **•••** > Edit.

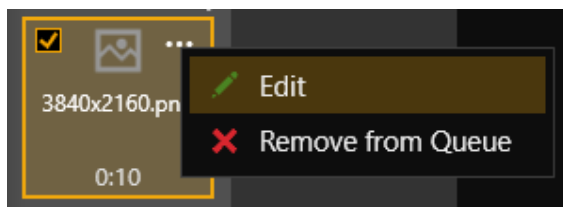

3. Optional: For video clips clear the Play to end option.

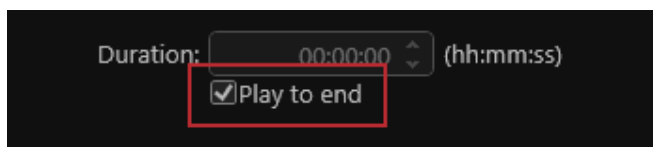

4. Edit the duration of the item, and select Update Item.  
The maximum duration is 23 hours, 59 minutes, and 59 seconds.

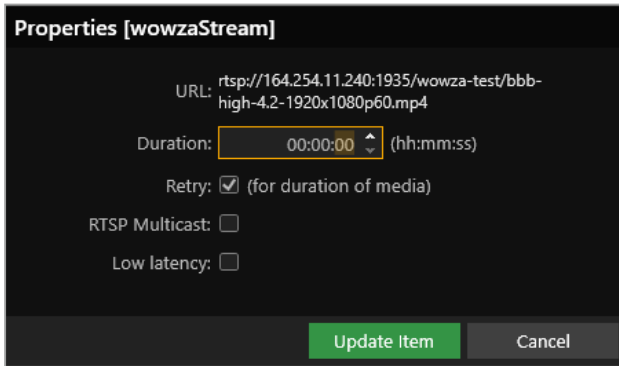

## Playing streams with low latency

You can play streams with low latency.

1. In the play queue, select the stream.
2. Select **⋮** > Edit.

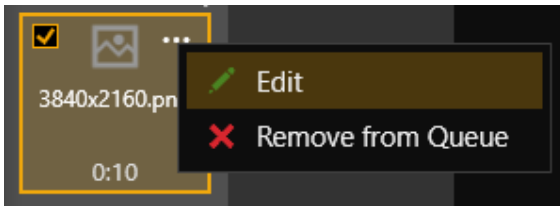

3. Select Low latency.

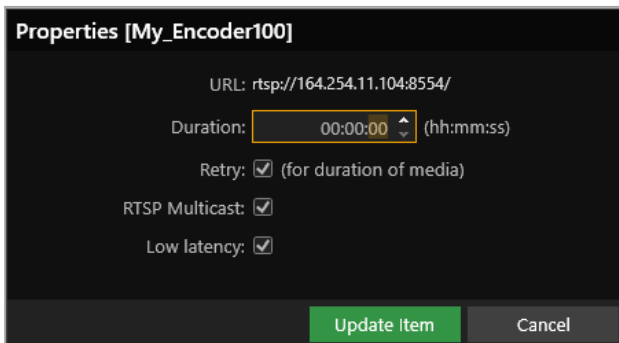

Repeat these steps for every item in the play queue that you want to play with low latency.

**!** CORIOmaster automatically disables the audio of streams with low latency. If you want to listen to audio from your stream, clear Low latency.

## Using the playback controls

When the play queue is playing, you can:



Stop playback



Pause playback



Skip to the next item



Return to the previous item

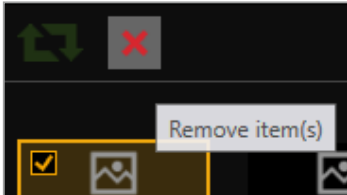

Remove an item from the play queue

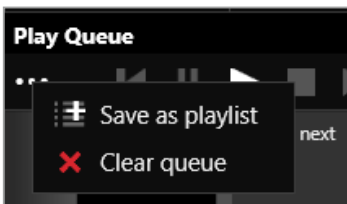

Clear the play queue

When the play queue is stopped, you can:



Enable and disable looping



Play the play queue

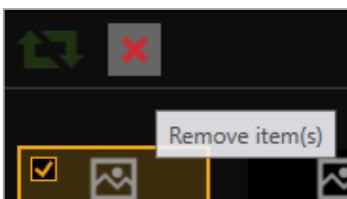

Remove an item from the play queue

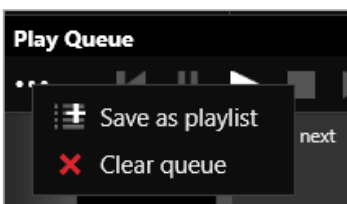

Clear the play queue

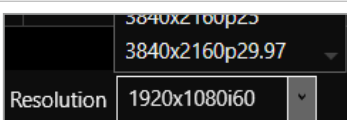

Change the resolution of the play queue

## Managing the play queue

When the play queue is playing or stopped, you can:

- Drag new media items or streams into the play queue, up to a total of 20 items.
- Drag items to re-order the play queue.
- Change the duration of a media item in the play queue.
- Remove any item from the play queue.
- Clear the entire play queue.
- Choose to play the play queue when your CORIOmaster starts up.
- Drag a playlist into the play queue.  
Dragging a playlist into the play queue replaces the existing play queue.



## Saving the play queue

You can save your play queue so that it is available the next time you start your CORIOmaster.

- Build your play queue, and in  Editor select  Set device startup.

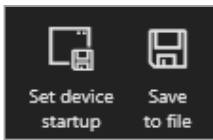

You can save your play queue as a playlist.

- Build your play queue and select  > Save as playlist.

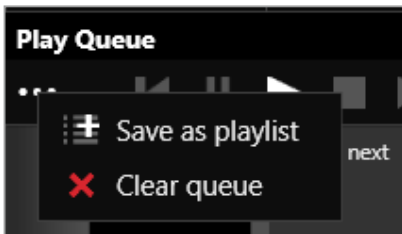

## Show labels for media and streams

You can choose to have labels shown on the video for your media and streams on your CORIOmaster.

1. Build your play queue and select Show label.

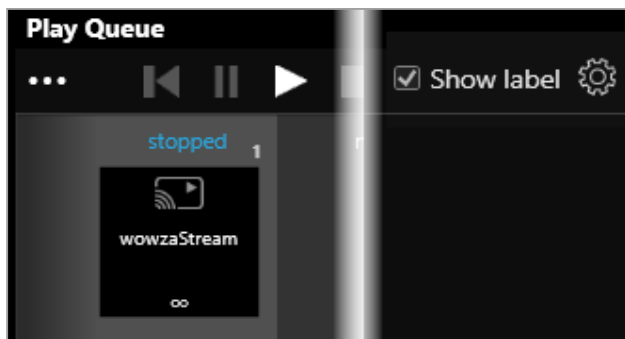

2. Select .
3. Choose, or set the options for the play queue label.

 Label options are for the play queue, so will apply to any items that are in the play queue.

4. Select Apply to send the changes to your device. The dialog will remain open.
5. Select Close to close the dialog.

 Close will discard changes that have not been applied.

## Playing the play queue automatically

You can choose to play the play queue automatically when you start your CORIOmaster.

1. Build your play queue and select Play on startup.

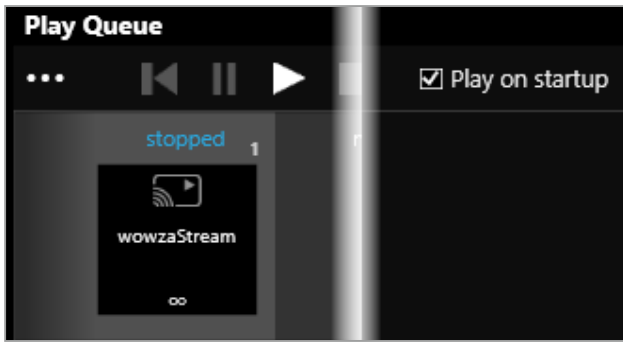

2. In Ino Editor, select  Set device startup.



## Saving media to internal storage

You can save media items from your USB drive to the internal drive.

Read more about the internal drive on page 116.

# Creating and managing playlists

If you have a Streaming media and 4K playback input module, you can save media items and video streams to playlists. Your CORIOmaster™ can store up to 20 playlists.

## In this article

About playlists .....	109
Creating a new playlist .....	110
Saving the play queue to a playlist .....	111
Managing and editing playlists .....	112
Deleting a playlist .....	114
Moving playlists between modules .....	114
Deleting all playlists .....	114
Duplicating playlists .....	115

Manage your media and streams in CORIOgrapher™. Double-click the window you wish to play media or streams, and select (Media Player) Manage.

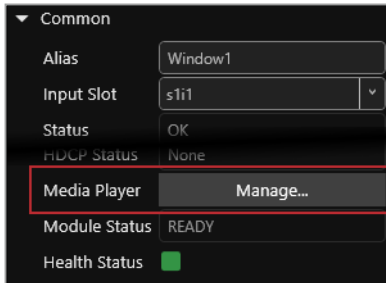

**!** The media player is not available when you work offline.

## About playlists

- Your CORIOmaster can store up to 20 playlists.
- Each playlist can include up to 20 items, including still images, video clips, and streams.
- Playlists are shared between the two channels of a Streaming media and 4K playback input module, but are not shared between Streaming media and 4K playback input modules.
- Playlists save the names and paths of media items and streams. If you change the name, path name, or location of an item, the playlist cannot find it.
- You can create new playlists from scratch, or save your play queue as a playlist.
- Playlists are saved on your CORIOmaster.
- You can choose to save or delete your playlists when you restore your CORIOmaster to factory default settings.

## Creating a new playlist

1. Select Playlists > +.

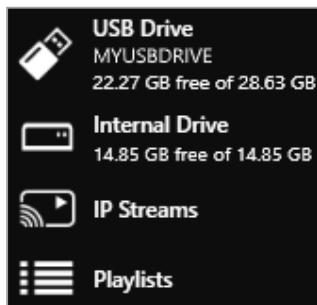

2. Enter a name and choose a resolution for your playlist.  
Names can be up to 64 characters long, or fewer, depending on your character set.

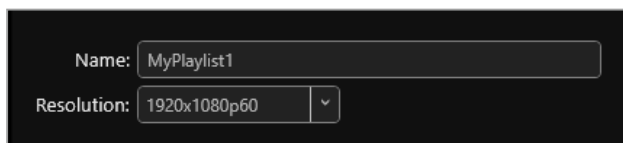

Read about choosing the right resolution on page 119.

3. Select your new playlist.

The playlist opens in the playlist editor. If the playlist editor is collapsed, select ► to open it.

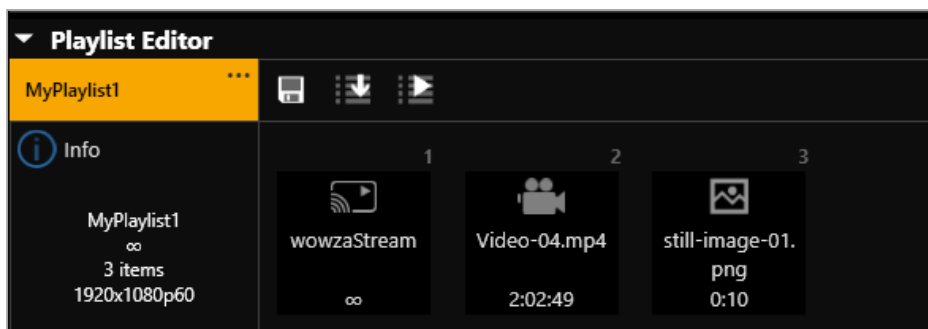

4. Drag up to 20 media items and streams from the media browser into the playlist editor.
5. Make any changes to your playlist.
  - To reorder the playlist, drag and drop media items and streams.
  - To remove something from the playlist, select the media item or stream and select ⋮ > Remove from playlist.
  - To remove all items from the playlist, select ⋮ > Clear all items.

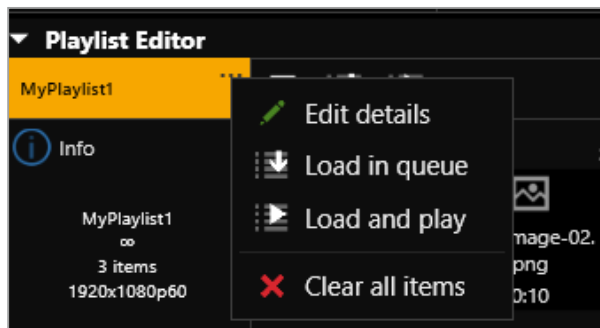

- To change the properties of an item, select the item, and then select ⋮ > Edit.

You can change the duration of an item in the playlist.

You can choose to play a stream with low latency.

! If you choose to play a stream with low latency, CORIOmaster disables the audio from your stream.

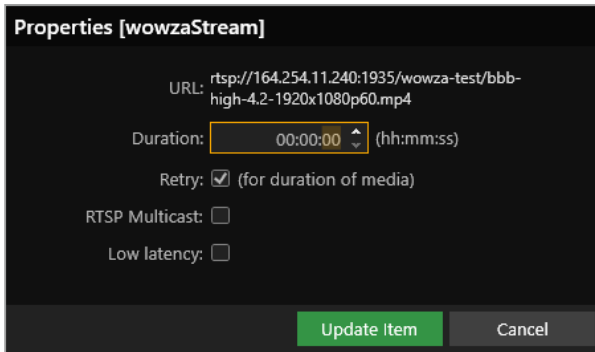

6. To save your playlist permanently, select .

## Saving the play queue to a playlist

1. From the play queue, select **⋮** > Save as playlist.

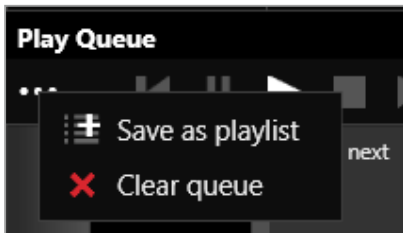

2. Choose to create a new playlist, or to replace an existing playlist.
3. If you create a new playlist, enter a name and choose a resolution for your playlist.

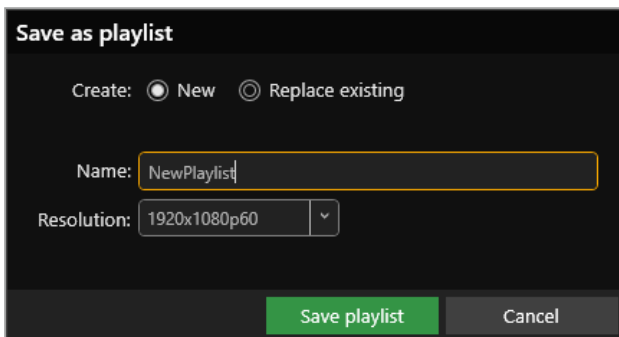

4. If you replace an existing playlist, select a playlist to replace from the list. You can enter a new name and choose a new resolution for the playlist if you want to.

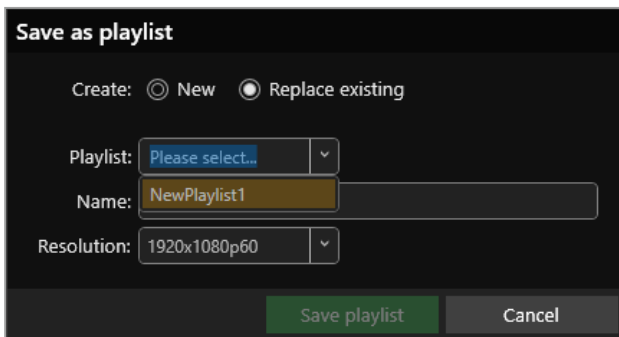

Names can be up to 64 characters long, or fewer, depending on your character set.

Read about choosing the right resolution on page 119.

## Managing and editing playlists

You can edit playlists, clear all the items from a playlist, and open a playlist to edit the items. You can load a playlist to the play queue, and play a playlist.

You can also manage the names and locations of your playlists in ⚙ Settings > Playlists.

Read more about configuring playlist settings on page 58.

## Editing a playlist

You can change the name and resolution of a playlist.

1. Select Playlists and select a playlist.
2. Select ⋮ > Edit details.

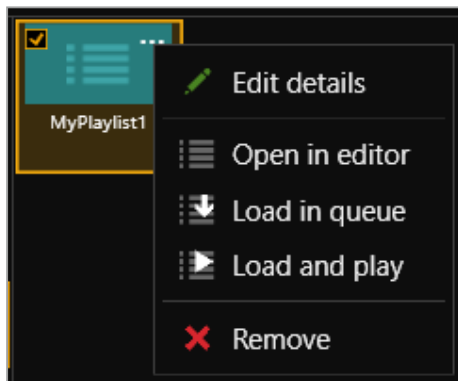

3. Enter a new name or choose a new resolution.

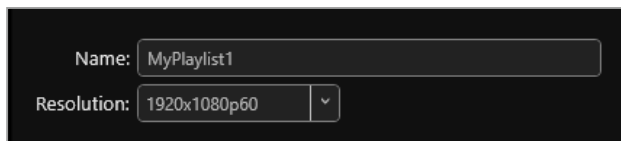

## Clearing all the items from a playlist

- From the playlist editor, select ⋮ > Clear all items.

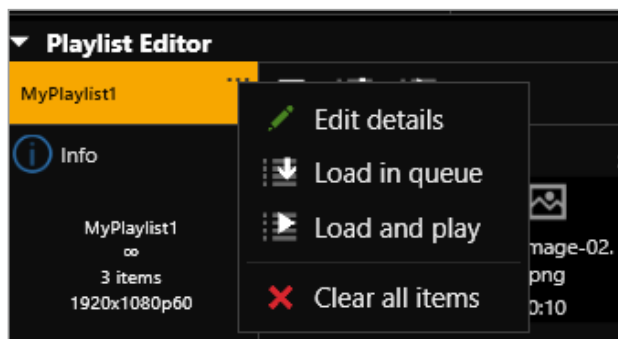

## Opening a playlist to edit the items

1. Select Playlists and select a playlist.
2. Select ⋮ > Open in editor.

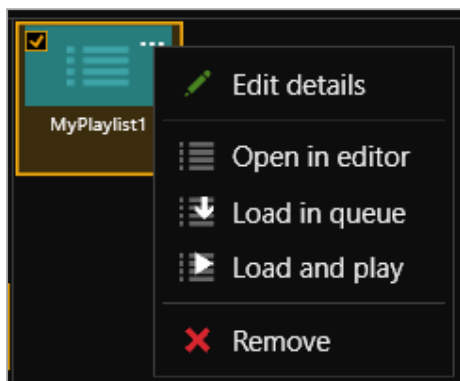

Read about the changes you can make to a playlist in [Creating a new playlist](#) above.

## Loading a playlist to the play queue

When you load a playlist, any items in the play queue are replaced, and playback stops.



You can:

- Drag a playlist into the play queue
- Select a playlist and select ⋮ > Load in queue.
- From the playlist editor, select .

## Playing a playlist

When you load and play a playlist, any items in the play queue are replaced.

You can:

- Drag a playlist into the play queue and select .
- Select a playlist and select ⋮ > Load and play.
- From the playlist editor, select .

## Deleting a playlist

- Select a playlist and select **⋮** > Remove.

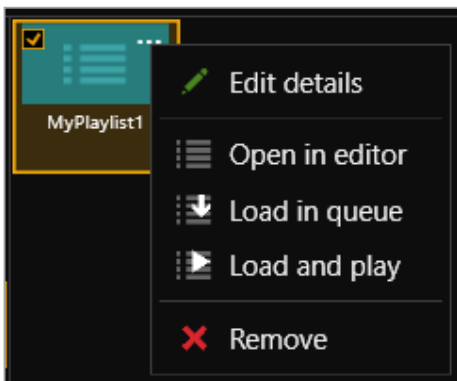

## Moving playlists between modules

You can change the slot that a playlist is associated with in **⚙ Settings > Playlists**.

Number	Name	Module	Resolution	
1	Playlist1	Slot1	1920x1080p60	Remove
2	Playlist2	Slot1	1920x1080p60	Remove
3	Playlist3	Slot1	1920x1080p60	Remove

Read more about configuring playlist settings on page 58.

## Deleting all playlists

You can delete all your playlists in **⚙ Settings > Playlists**.

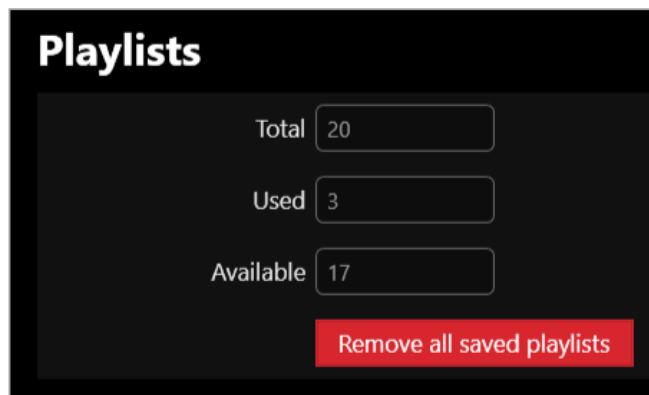

Read more about configuring playlist settings on page 58.



## Duplicating playlists

If you want several playlists to contain the same items, you can create a play queue and then save it under several different names.

For example, you might want all your playlists to contain a particular stream, and your company logo.

1. Drag items into the play queue.
2. From the play queue, select **⋮** > Save as playlist.

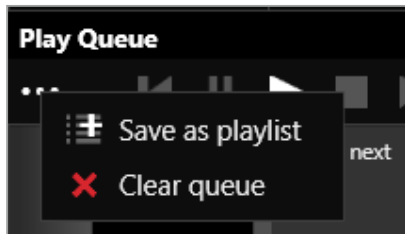

3. Enter a name and choose a resolution for your playlist.

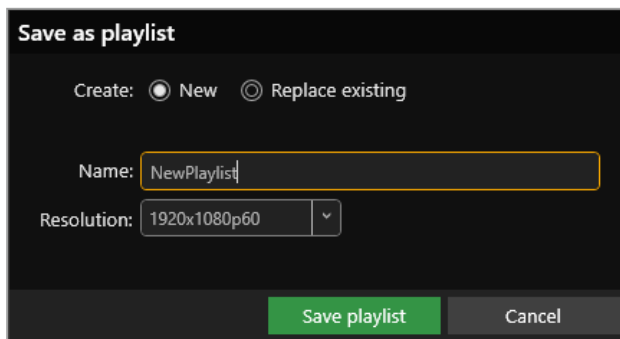

4. Repeat steps 2 and 3. Enter a unique name for the playlist each time.
5. Open each new playlist and add items in the playlist editor.

## Using the internal drive

You can save media to the internal drive of your Streaming media and 4K playback input module. You can manage your saved media, and add media items to a playlist or play queue.

### In this article

Replacing all items on the internal drive with all items on the USB drive .....	116
Removing all items from the internal drive .....	117
Current location .....	117
Copying a single item or folder to the internal drive .....	117
Managing media on the internal drive .....	117
Playing items from the internal drive .....	118

Manage your media and streams in CORIOgrapher™. Double-click the window you wish to play media or streams, and select (Media Player) Manage.

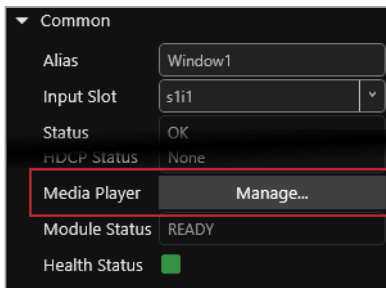

! The media player is not available when you work offline.

## Replacing all items on the internal drive with all items on the USB drive

✓ Use this option when you first set up your Streaming media and 4K playback input module to easily copy all your media items from your USB drive to the internal drive.

You can replace all the items on your internal drive with the items on your USB drive. All items currently on the internal drive are deleted.

All items on your USB drive are copied exactly to the internal drive, including folders and folder structure, up to path names of 480 characters, or fewer, depending on the language you use.

! Items that aren't compatible with your Streaming media and 4K playback input module are copied to the internal drive, but not displayed. These items use memory, and you can't remove them manually. To remove hidden items, remove all items from the internal drive.  
See the Streaming media and 4K playback module specification document for a list of compatible file types.

## To replace all items on the internal drive with all items on the USB drive

- Select (USB Drive) ⋮ > Replace all items on the internal drive.

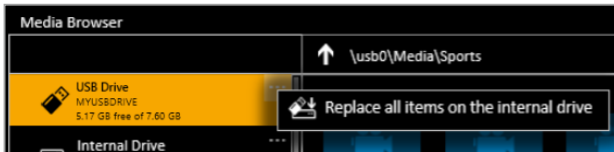

## Removing all items from the internal drive

You can remove all visible and hidden items from the internal drive.

- Select Internal Drive > Clear all items.

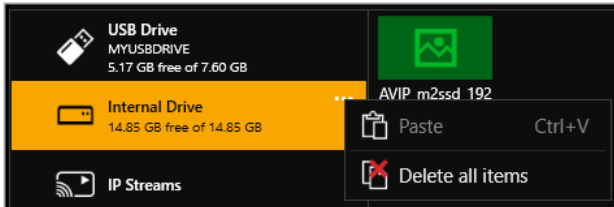

## Current location

When you copy media items from your USB drive to the internal drive, the items are copied to the last location you visited on the internal drive.

For example, you create a folder on the internal drive called *Videos*. You open *Videos* and then select USB Drive. You select a media item and copy it to the internal drive. The media item is copied to *Videos*.

## Copying a single item or folder to the internal drive

You can copy individual media items and folders from your USB drive to the internal drive. Items are copied to the last location you visited on the internal drive.

1. From USB Drive, select a media item or folder.
2. Select ⋮ > Copy to internal drive (current location).

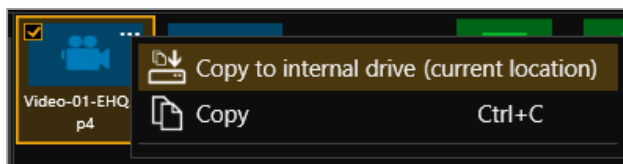

You can also copy and paste individual items and folders from your USB drive to the internal drive with Ctrl+C and Ctrl+V.

## Managing media on the internal drive

From Internal Drive, you can:

- Copy or cut and paste individual items and folders.  
Select a media item or folder, and then select ⋮ > Copy or Cut. Right-click in an empty space and select Paste.
- Copy or cut and paste individual items and folders with Ctrl+C or Ctrl+X, and Ctrl+V.
- Delete media items and folders.  
Select a media item or folder, and then select ⋮ > Delete.

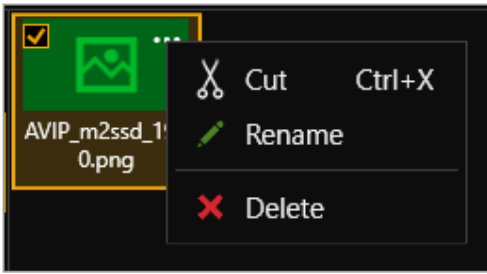

- Create a new folder.

Right-click in an open space, and select New folder. Enter a name for your folder.

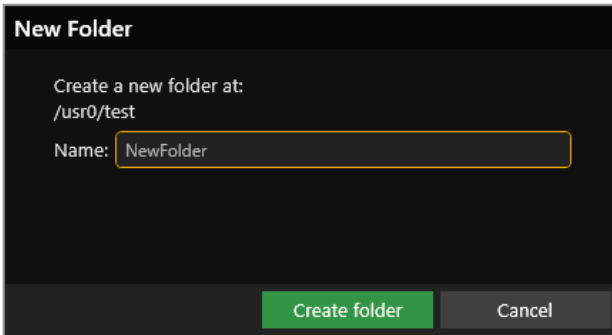

- Rename media items and folders.

Select a media item or folder, and then select **⋮** > Rename.

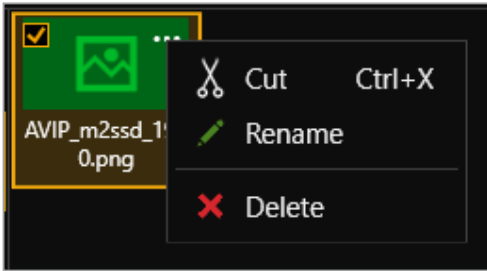

## Playing items from the internal drive

You play items from the internal drive in the same way you play all media items and streams. Drag items into the play queue, or into a playlist.

Read more about playing media and streams on page 98.

Read more about playlists on page 109.

## Choosing the best resolution for your playlist or play queue

The best resolution for your play queue or playlist depends on the frame rate of your media items, and their size in pixels.

The resolution you choose determines the input resolution used within your device. All media items in the play queue or playlist are automatically scaled to fit this resolution. If you find that the resolution you choose doesn't give you the results you want, you can change this resolution whenever you want.

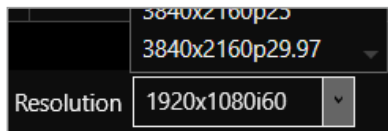

The Streaming media and 4K playback input module supports two simultaneous channels playing media. The two channels can have different resolutions, and you can choose a custom value for channel one (slot  $n$  position 1). Channel two (slot  $n$  position 2) only supports 1920x1080p60.

### Understanding the format of resolution

Resolution is shown in the form:

Width x Height (in pixels), p or i, Frame Rate (in Hz, or frames per second)

Where p means progressive scanning, and i means interlaced scanning.

For example, 1920x1080i60 is 1920 pixels wide, 1080 pixels high, interlaced, and has a frame rate of 60 Hz.

### How do I know what resolution my media items are?

To find the resolution of a media stream, visit the source of the stream.

To find the resolution of a media item, select the item in the media browser. Information about that item is displayed on the right.

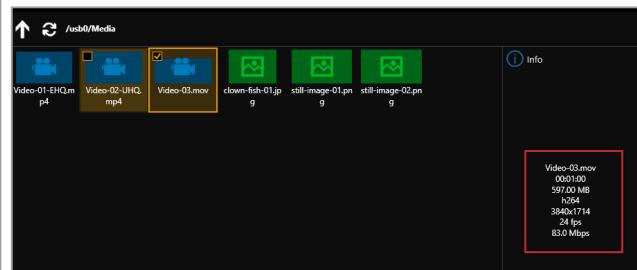

## Frame rate

- For best results, add video clips and media streams with the same frame rate to a play queue. You can then choose a resolution with a frame rate that matches your media items.

	Video clip 1	Video clip 2	Video clip 3
✓	1920x1080p60	3840x2160p60	1600x1200p60

- If you have a mixture of frame rates, choose a resolution with a frame rate that is a factor of your frame rates. For example, you can add media items with frame rates of 30 Hz and 60 Hz, and then choose a resolution with a frame rate of 60 Hz. You can do this because you can divide 60 by 30.

Note: don't round up frame rates. For example, don't treat 23.98 Hz as 24 Hz.

	Video clip 1	Video clip 2	Video clip 3	Best frame rate	Reason
✓	1920x1080p60	3840x2160p30	1600x1200p60	60	Both frame rates are a factor of 60. $60/60 = 1$ $60/30 = 2$
✓	3840x2160p25	1920x1080p50	1280x720p50	50	Both frame rates are a factor of 50. $50/50 = 1$ $50/25 = 2$
✗	1280x720p23.98	1280x720p24	1920x1080p60	-	This play queue doesn't work because 24 is not a factor of 60, and you can't round 23.98 up to 24.

## Resolution

- Choose a resolution no larger than your largest media item. Upscaling at this stage takes up unnecessary bandwidth.
- Don't choose a resolution that is much smaller than your media items. Downscaling at this stage can cause your media to appear blocky and low in quality when it is upscaled later in the process.
- If you have a play queue with a wide range of resolutions, you could choose a resolution in the middle of the range. This means that your largest items are downscaled.
- Consider the types of media you want to play. If you have, for example, two large 4K video clips and two smaller still images, you might prefer to put up with poorer quality still images in return for best quality video. In this case, choose your resolution based on the size of the video clips.

## Scanning

- Avoid mixing media items with progressive scanning and media items with interlaced scanning in the same play queue.

## Using the buttons of your CORIOmaster micro™

You can use the buttons of your CORIOmaster micro™ to select presets and sources, and to lock your CORIOmaster micro.

### In this section

Changing between preset and source selection mode with your CORIOmaster micro™ .....	121
Locking your CORIOmaster micro™ .....	121

## Changing between preset and source selection mode with your CORIOmaster micro™

To change between preset selection mode and source selection mode, press and hold buttons 1 and 5. When the mode changes, the button color changes. In preset selection mode, the buttons are orange. In source selection mode, the buttons are green.

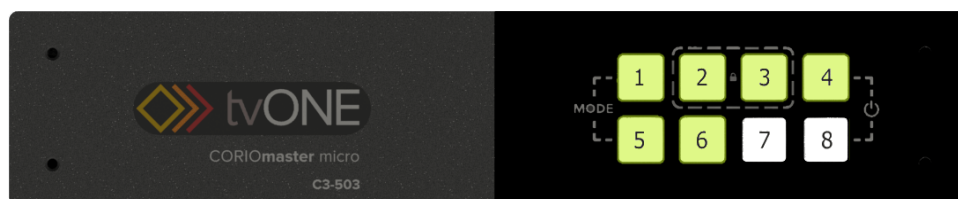

## Locking your CORIOmaster micro™

### Locking your CORIOmaster micro with the front panel

To lock and unlock your CORIOmaster micro™, press and hold buttons 2 and 3.

When your CORIOmaster micro is locked, buttons 2 and 3 turn red.

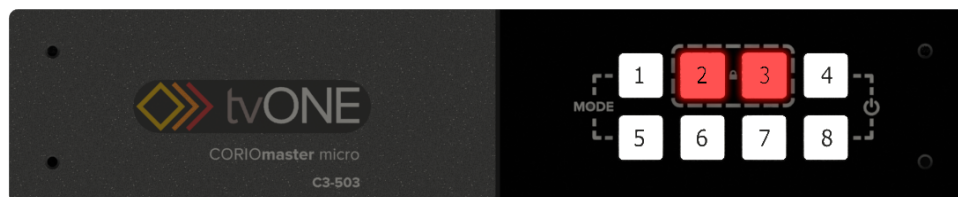

### Locking your CORIOmaster micro in CORIOgrapher™

1. Select  > (Front Panel) Settings.
2. Select or clear Lock.

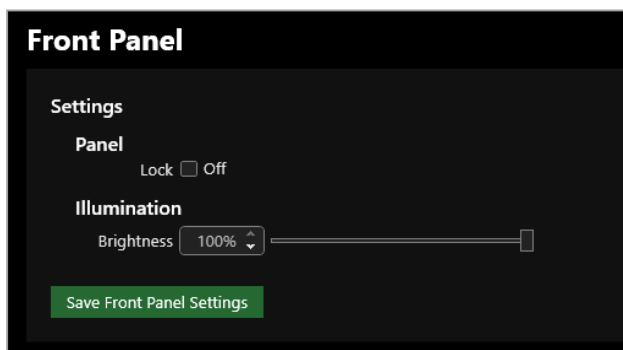

## Replacing a module

### Risk of damaging modules

Take care when you replace modules. If the components of modules touch other modules, or the metal chassis, they can be damaged. If you don't have experience, ask a qualified technician for help.

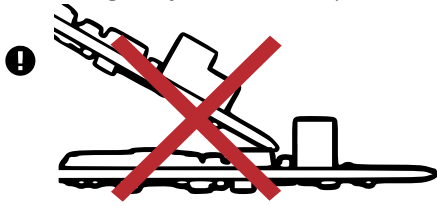

### Removing a module from your CORIOmaster™

1. Unscrew the module that you want to replace.

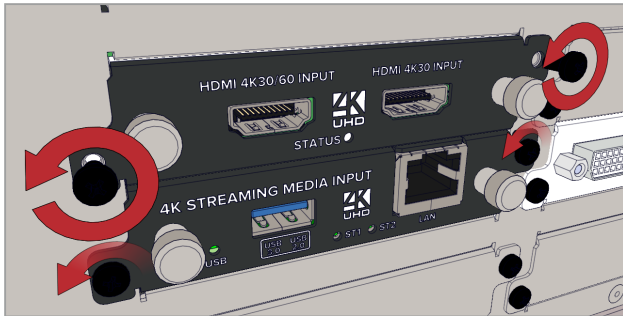

2. Loosen the screws of the module above or below the module that you want to replace.



3. Grip the silver handles and pull the module forward, out of your CORIOmaster.

Modules with four or more inputs or outputs can be difficult to remove by hand. Some modules are designed with one or two small notches. Use the extractor tool that came with your module to hook into the notches and pull out the module.





## Inserting a module into your CORIOmaster

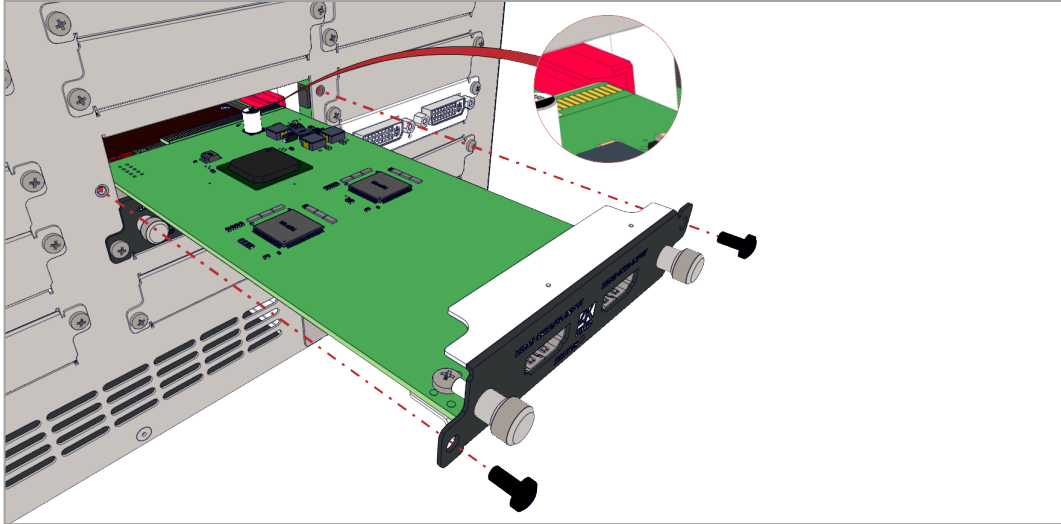

1. Insert the module into the guide rails of your CORIOmaster.
2. Push the module firmly into the dock at the rear of your CORIOmaster.
3. Screw the module in place.
4. Tighten the screws of the module above or below.

## Removing a module from a CORIOmaster micro™

If you need to replace the module in slot 3, first remove the module in slot 1.



1. Remove the top cover of your CORIOmaster micro.

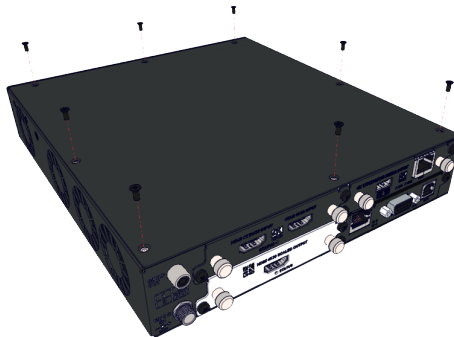

2. Remove the screws of the module or modules you want to replace. Loosen the screws of the module below the module that you want to replace.



3. Grip the silver handles and pull the module forward a short distance, out of the dock on the back plane. Lift the module out of your CORIOmaster micro. Keep the module flat.

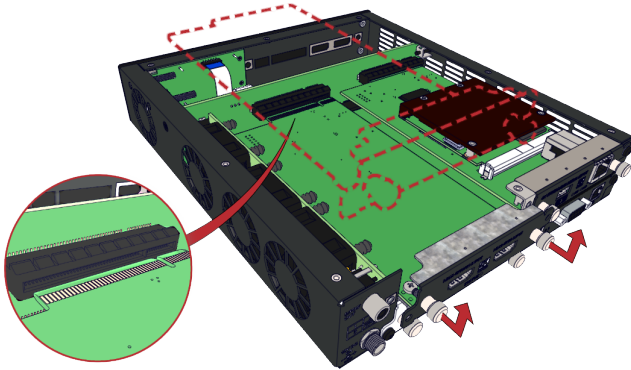

Modules with four or more inputs or outputs can be difficult to remove by hand. Some modules are designed with one or two small notches. Use the extractor tool that came with your module to hook into the notches and pull out the module.



## Inserting a module into your CORIOmaster micro

1. Carefully lower the module into your CORIOmaster micro, and then push the module firmly into the dock on the back plane.

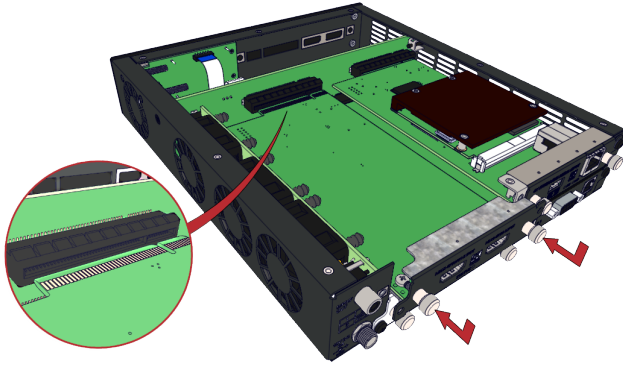

2. Replace the screws and do them up loosely.
3. Replace the top cover of your CORIOmaster micro.



4. Tighten all screws.

## Adding and managing custom EDID files

You can upload an EDID file saved to your PC to your CORIOmaster™. You can manage the EDID files saved to your CORIOmaster in CORIOgrapher™.

 Your uploaded EDID files can only be used with sources.

You might want to upload a saved EDID file if a source, for example, a PC, is using the preferred resolution from your CORIOmaster rather than the resolution you wanted for the source device. This can cause unexpected effects. You can create an EDID file for the resolution you selected for the source device, and upload it to your CORIOmaster.

EDID files must:

- Be a binary EDID file
- Have a filename in 8.3 format
- Have a .edd extension
- Have a filename no longer than 8 ASCII characters

**Risk of unexpected results**

 CORIOgrapher does not check that a custom EDID file is valid or supported. Uploading an invalid or unsupported EDID file can cause source loss and unexpected results. Creating custom EDID files is an advanced task. If in doubt, contact a qualified AV professional.

### Before you start

Before you add custom EDID files or remove saved EDID files, we recommend that you make a backup copy of your configuration.

**Risk of losing EDID data**

 Firmware version M407 contains updates to system EDID files. When you've updated from version M406 or below to version M407 or above, do not restore a backup from a lower firmware version.

Read more about backing up and restoring on page 48.

### Adding a saved EDID file

1. In CORIOgrapher, select  Settings > EDID Manager.
2. Select Install new EDID.
3. Select Select EDID file and browse to an EDID file on your PC.
4. Select Start install.

### Removing EDID files

**Risk of unexpected effects**

 If you delete an EDID file that is in use and then reboot your CORIOmaster, your CORIOmaster says it is using the deleted EDID file but is actually using the default EDID file. Take care to not delete EDID files that are in use.

1. In CORIOgrapher, select  Settings > EDID Manager.
2. Find the EDID file you want to delete.
3. Select Remove.

## Troubleshoot it

This section contains frequently asked questions and advice on troubleshooting problems with your CORIOmaster™. If you can't find the help you need, contact your distributor, and if they can't help, contact tvONE™ support. Contact details are at the back of this guide.

### In this section

Checking and updating the firmware of your CORIO device .....	128
I can't see my CORIOmaster™ in the Discovered Devices list .....	130
I can't log in to CORIOgrapher™ .....	132
I can't log in securely to CORIOgrapher™ .....	133
The picture keeps coming and going on my CORIOmaster™ .....	135
My Streaming media and 4K playback input module keeps overheating .....	136
I can't hear any audio .....	137
I can't update the firmware of my Streaming media and 4K playback input module .....	145
General troubleshooting checklist .....	146
Returning a product for repair .....	146
What are the minimum requirements for running CORIOgrapher? .....	146
What's the password for my CORIOmaster™? .....	147
Can I use HDMI extenders with CORIOmaster™ output modules? .....	147
Where can I put Streaming media and 4K playback input modules? .....	147
How large is the internal storage on a Streaming media and 4K playback input module? .....	147
How do I find the MAC address of my Streaming media and 4K playback input module? .....	147
How fast is my connection to the Streaming media and 4K playback input module? .....	148
Which media formats can I add to a play queue? .....	148
Can I save my play queue? .....	148
How do I mute audio? .....	148

## Checking and updating the firmware of your CORIO device

You must be connected to your CORIOmaster™ to check and update firmware.

Find your firmware version from CORIOgrapher™ > Home. Update your firmware from CORIOdiscover > Update Device.



When you update the firmware, any unsaved configuration in CORIOgrapher is deleted. Make sure you save any configurations that you want to keep before you start the updating process. You can also save a backup file on your PC. Read about saving a backup file on page 48.

### Before you start

To install the latest firmware for your device, you need CORIOdiscover V1.7 or above. CORIOdiscover software is available from [help.tvone.com/r/docs/g/software](http://help.tvone.com/r/docs/g/software).

### Checking your firmware version and downloading new firmware

CORIOdiscover warns you if you try to install firmware that is older or the same as your existing firmware. If you don't want to check your existing firmware version, skip to step 2.

1. In CORIOgrapher > Home, find your current firmware version next to the name of your device.

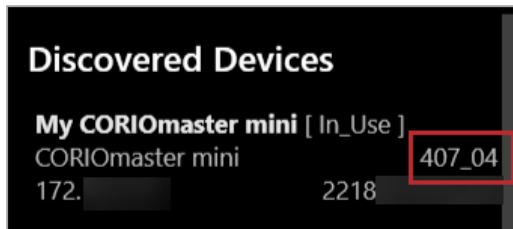

2. Check for newer firmware at [help.tvone.com/r/docs/g/firmware](http://help.tvone.com/r/docs/g/firmware).  
Select your device from the list and compare the firmware version to your own.
3. If your firmware is out of date, download the zipped DAT file.  
You don't need to extract the DAT file.

## Updating the firmware

1. In CORIOdiscover, select .



2. Select your device from the list and select Update.
3. To save your device settings, select Save Device Settings.

When you save your settings, your device keeps all your saved configurations and canvases.

 Risk of losing custom EDID file and/or secure certificate when updating from firmware version M406  
If you have a custom EDID file and/or a secure certificate from firmware version M406 or below, your EDID file and/or secure certificate is not saved when you select Save Device Settings.  
For help updating to firmware versions M407 and above, contact customer support.  
See contact details on page 150.

4. Enter your administrator login details.

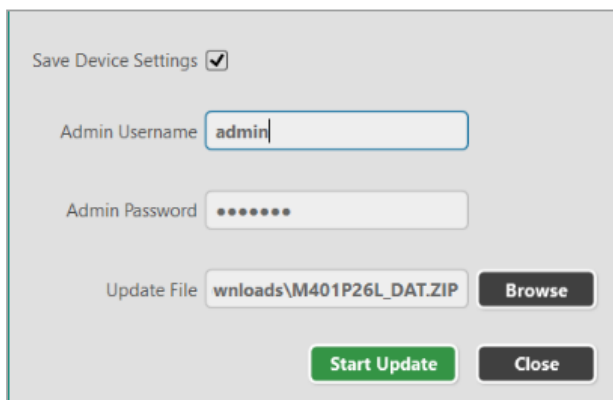
A screenshot of the "Save Device Settings" dialog box. At the top, there is a checkbox labeled "Save Device Settings" which is checked. Below this, there are three input fields: "Admin Username" with the text "admin", "Admin Password" with a masked password of seven dots, and "Update File" with the text "wnloads\M401P26L\_DAT.ZIP" and a "Browse" button to its right. At the bottom of the dialog, there are two buttons: "Start Update" (in green) and "Close" (in grey).

5. Browse to the zipped DAT file that you downloaded.
6. Select Start Update.

When the update is finished, you can log in to your device again.

# I can't see my CORIOmaster™ in the Discovered Devices list

## What's the problem?

When I tried to find my CORIOmaster, CORIOmaster mini™, or CORIOmaster micro™ in the Discovered Devices list on the Home window of CORIOgrapher™, I couldn't see it. I tried refreshing the list and it still wasn't there.

## Why does this happen?

There might be a lot of devices on your network and you're having trouble identifying yours.

Your device might be on a different network, there might be a problem with your network or firewall, or you might be in a high-security environment.

## What to do

### First try this

If you've got a long list of devices with similar names, try these steps to find out which one is yours.

1. Write down the list or take a screenshot, and then turn off your device.  
After a few seconds, your device should show as offline.
2. If nothing shows as offline, close and open CORIOgrapher.
3. Compare the list to your screenshot.  
If a device is missing, it is most likely your device.
4. Turn on your device, wait up to ten minutes, and see if that device appears again in the list.  
You can now select your device.

### Then try this

If your device definitely isn't in the Discovered Devices list, first check your hardware.

If your device still isn't in the list, connect directly to your device with an RS-232 serial connection, find the IP address of your device, and use that IP address to log in.



API commands are not case-sensitive.

## To check your hardware and firmware

1. Check that your device is turned on and the LED on the front panel is green.
2. Turn your device off and on again.
3. When the LED on the front panel is green, on the Home window of CORIOgrapher, select Refresh.
4. Check the Ethernet or serial connectors that connect your device to your computer.
5. Check that you are using the latest firmware. You might need to update your firmware.

Read about checking and updating your firmware on page 128.

## To find out the IP address of your device

1. Connect the RS-232 port on your device to the RS-232 port on your computer with an RS-232 cable.
2. Open a suitable terminal application, such as puTTY or HyperTerminal.
3. Set your COM port settings to the following:

Speed (baud)	115200
Data bits	8
Stop bits	1



Parity                      None  
Flow control              None

4. To log in to your device as an administrator, enter `login (admin, adminpw)`.  
Admin and adminpw are the default administrator login details. If you've changed them, use your own login details.
5. To check that DHCP is enabled, enter `System.Comms.Ethernet.DHCP` and press Return.  
If the Enabled property is set to Off, then go to step 6.  
If the Enabled property is set to On, then go to step 7.
6. Enter `System.Comms.Ethernet` and press Return.
7. Find the IP address of your device in the IP\_Address property and make a note of it.
8. Enter `logout ()` and press Return.

## To log in to your device with an IP address

Log in to your device on the  Home window of CORIOgrapher.

1. Select Connect to your device.
2. Enter the IP address that you got from the serial connection, and your administrator login details.

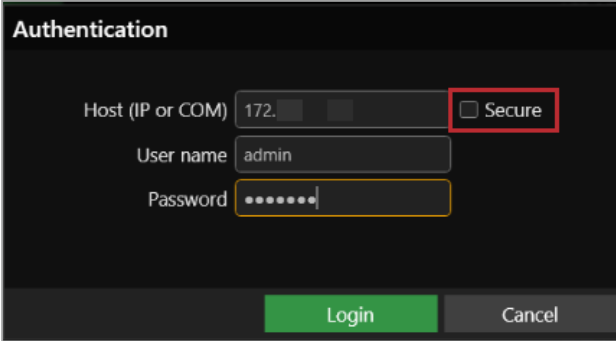

The first time you log in, make sure Secure is clear.

## If that doesn't work

There might be a problem with your network or firewall. Talk to your network administrator. You might need to give your device a specific IP address.

Read about changing the IP address of your device on page 54.

If the advice here doesn't work, first contact your distributor. If your distributor can't help, contact tvONE support at [tech.usa@tvone.com](mailto:tech.usa@tvone.com), [tech.europe@tvone.com](mailto:tech.europe@tvone.com) or [tech.asia@tvone.com](mailto:tech.asia@tvone.com).

# I can't log in to CORIOgrapher™

## What's the problem?

When I try to log in, I get an error message.

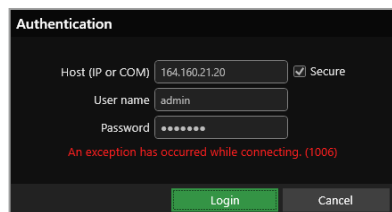

## Why does this happen?

CORIOgrapher is unable to make a connection to your CORIOmaster. There are multiple reasons why a connection can't be made.

## What to do

### First try this

If you are getting a 1002 error code, then there may have too many controllers communicating with your device, and the device has ran out of connection slots.

Check if you have multiple controllers that are using the REST API or Ethernet.

Disconnect the controllers , and reboot the device, then try to connect again.

### Then try this

Check the rfc6455 specification website for help with WebSocket status codes.

<https://datatracker.ietf.org/doc/html/rfc6455#section-7.4>

### If that doesn't work

If the advice here doesn't work, first contact your distributor. If your distributor can't help, contact tvONE support at [tech.usa@tvone.com](mailto:tech.usa@tvone.com) , [tech.europe@tvone.com](mailto:tech.europe@tvone.com) or [tech.asia@tvone.com](mailto:tech.asia@tvone.com).

# I can't log in securely to CORIOgrapher™

## What's the problem?

When I select Secure and try to log in, I get an error message.

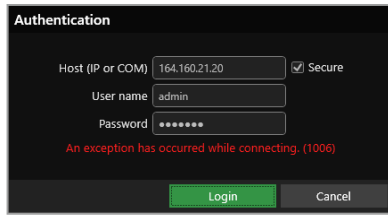

## Why does this happen?

Your CPU module might not have a Real Time Clock (RTC) installed. CORIOmaster units purchased from 2019 include an RTC.

If your CPU module includes an RTC, it might not have generated a secure certificate.

## What to do

### First try this

Check if you have an RTC installed.

1. Clear the Secure option and log in to CORIOgrapher.
2. Select ⚙ Settings > Networking.

If you see error message You cannot set the time on a device that does not have a real time clock, your CPU does not have an RTC installed.

If you do not see the error message, generate a secure certificate.

1. From Networking, select Secure connection.

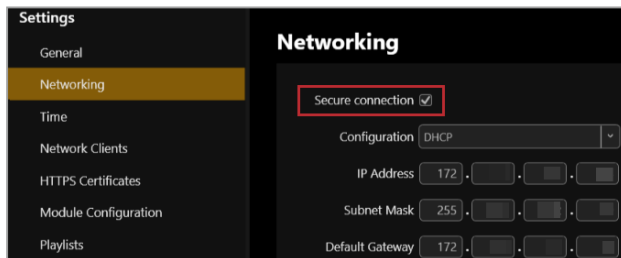

2. Select Save > Yes.  
Your device restarts.
3. Select Secure and log in.

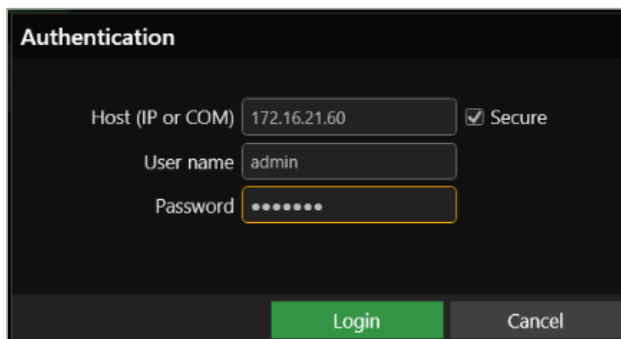

## Then try this

If your CPU module does not include an RTC, purchase a new CPU.

- If you have a CORIOmaster, ask your distributor for part number [cm-c3-540-cpu-https](#)
- If you have a CORIOmaster mini, ask your distributor for part number [cm-c3-510-cpu-https](#)
- If you have a CORIOmaster micro, ask your distributor for part number [cm-c3-503-cpu-https](#)

With your new CPU, generate a secure certificate.

## If that doesn't work

If the advice here doesn't work, first contact your distributor. If your distributor can't help, contact tvONE support at [tech.usa@tvone.com](mailto:tech.usa@tvone.com) , [tech.europe@tvone.com](mailto:tech.europe@tvone.com) or [tech.asia@tvone.com](mailto:tech.asia@tvone.com).

# The picture keeps coming and going on my CORIOmaster™

## What's the problem?

The display is continually dropping the signal and attempting to reconnect. The HDMI status property of the display switches between Found and Not\_Found.

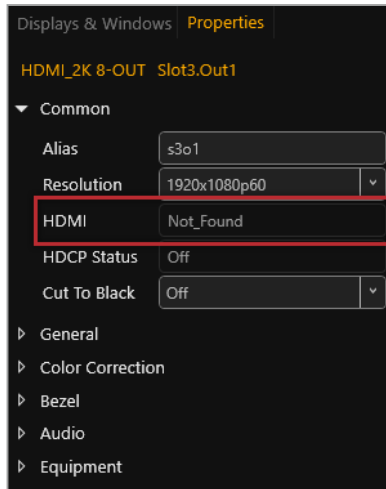

## Why does this happen?

You probably have a display or output that doesn't support HDCP (High-bandwidth Digital Content Protection).

## What to do

### First try this

1. From  Editor, double-click the display.
2. Select General and set HDCP Mode to KeepOff.

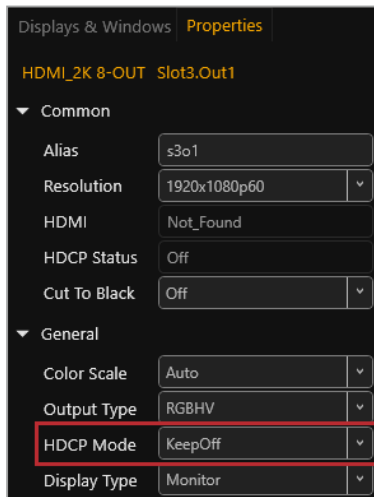

## If that doesn't work

If setting HDCP Mode to KeepOff doesn't work, try setting HDCP Mode to FollowSources.

If the advice here doesn't work, first contact your distributor. If your distributor can't help, contact tvONE support at [tech.usa@tvone.com](mailto:tech.usa@tvone.com) , [tech.europe@tvone.com](mailto:tech.europe@tvone.com) or [tech.asia@tvone.com](mailto:tech.asia@tvone.com).

# My Streaming media and 4K playback input module keeps overheating

## What's the problem?

I keep seeing an error message that tells me my Streaming media and 4K playback input module is too hot, or has overheated. The performance of the module is reduced. I've tried restarting my CORIOmaster™.

## Why does this happen?

If the environment around the Streaming media and 4K playback input module is too hot, the module runs above specification, or the fans can't do their job properly, the module can overheat. When the module becomes hot and there is a risk of overheating, the performance of the module is reduced to lower the amount of data processed.

## What to do

### First try this

1. Switch off your CORIOmaster.
2. Allow your CORIOmaster to cool down for at least 20 minutes.
3. Restart your CORIOmaster.

### Then try this

1. Place your hand near each fan outlet in turn and check that air is flowing out of your CORIOmaster.
2. Check the environment around your CORIOmaster.
  - Is there anything covering the fan outlets?
  - Is the space large enough?
  - Is there enough ventilation or cooling? For best results, make sure the air around your CORIOmaster is a maximum of 20 °C.
  - Is there an air gap all around your CORIOmaster?
3. If there are any issues with the environment around your CORIOmaster, switch off your CORIOmaster and allow it to cool down while you fix the issues.

### If that doesn't work

Is your Streaming media and 4K playback input module playing media items or streams that are very high resolution and/or high bitrate? Try reducing the resolution or bitrate as much as you can without losing too much quality.

If the advice here doesn't work, first contact your distributor. If your distributor can't help, contact tvONE support at [tech.usa@tvone.com](mailto:tech.usa@tvone.com) , [tech.europe@tvone.com](mailto:tech.europe@tvone.com) or [tech.asia@tvone.com](mailto:tech.asia@tvone.com).

# I can't hear any audio

## What's the problem?

I am trying to play audio but I can't hear it, or the sound is poor.

## Why does this happen?

General problems with audio:

- Audio is disabled for the input or output.
- The audio source is muted.
- The audio output is muted.
- The canvas or output is cut to black. Cut to black also mutes audio.
- The input audio level is turned down low, or the output volume is turned down low.
- The audio source was changed by a preset.
- The source device or output device might be muted.
- There might be a loose connection, mislabeled cables, or problem with your audio device.
- The audio source is not compatible with your CORIOmaster.
  - Your CORIOmaster only plays embedded audio in uncompressed PCM format.
  - Your CORIOmaster only plays audio with a frequency of 48 kHz.

If you're trying to play audio with the S/PDIF and analog audio module:

- You might have your audio device connected to the wrong output.  
Each output is associated with a single canvas. Output 1 is associated with canvas 1, and so on.  
Read more about the S/PDIF and analog audio module on page 22.

If you're trying to play audio with the Streaming media and 4K playback input module:

- You might be trying to listen to a stream with low latency. CORIOmaster automatically mutes streams with low latency.
- The audio from a media item might not be compatible with your Streaming media and 4K playback input module.

If you're trying to play audio using the S/PDIF output of a CORIOmaster micro:

- You might be listening to the wrong window.
- You might be listening to the wrong input.
- The source or output might be muted, or the audio input level is turned down too low.
- The audio from a media item might not be compatible with your Streaming media and 4K playback input module.
- There might be a loose connection or problem with your audio device.

## What to do

General problems with audio .....	138
Audio from the Streaming media and 4K playback input module	142
Audio from the S/PDIF output of a CORIOmaster micro .....	143
If that doesn't work .....	144

### General problems with audio

- *Check if audio is disabled for sources or outputs, page 138*
- *Check if sources are muted, page 139*
- *Check if input audio level or volume are too low, page 139*
- *Check if canvases or displays are cut to black and muted, page 139*
- *Check if displays or windows are muted, page 140*
- *Check your presets, page 141*
- *Check the format of your media items, page 141.*

### Check if audio is disabled for sources or outputs

1. Select  Settings > Slot Status.
2. Check that Audio Enabled is selected for each source and output that you want to use.

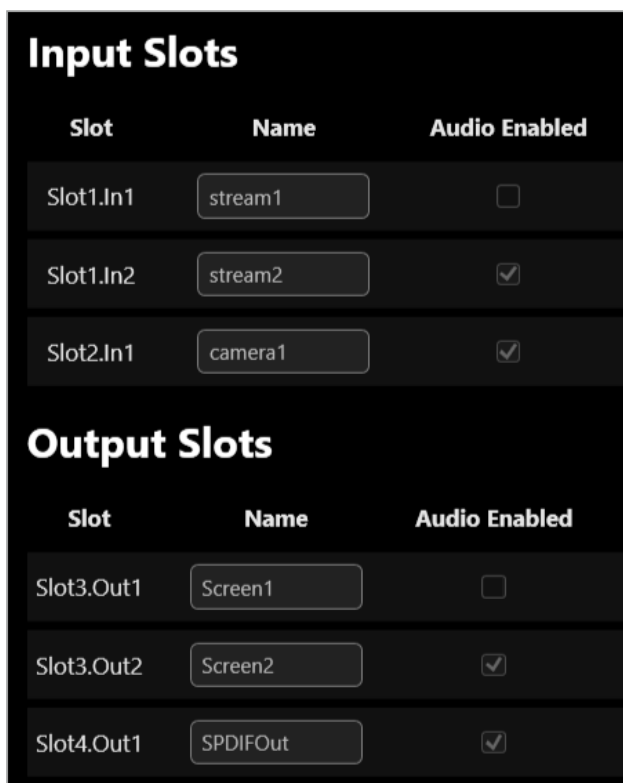



## Check if sources are muted

1. From  Editor, open the list of audio sources.

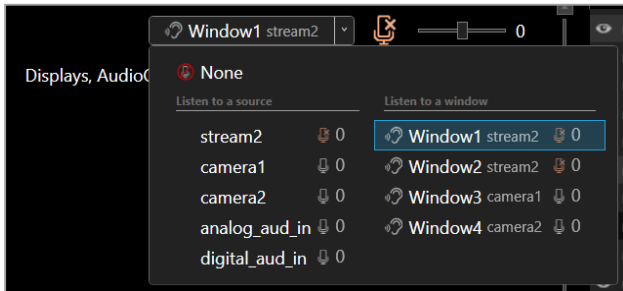

2. If the source you want to hear is muted, select the source and then select .

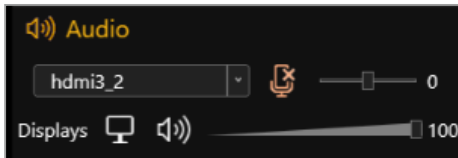

## Check if input audio level or volume are too low

1. From  Editor, check the output volume.

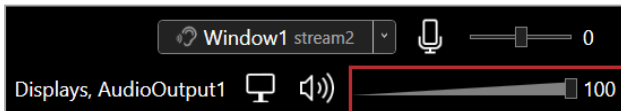



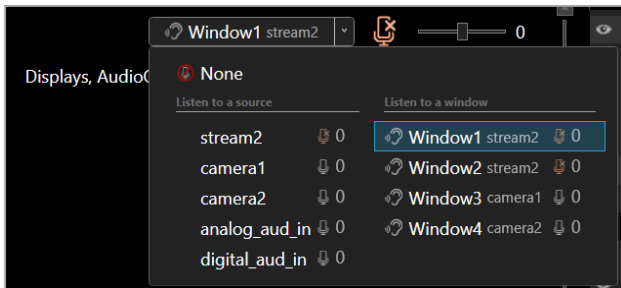

2. Open the list of audio sources.

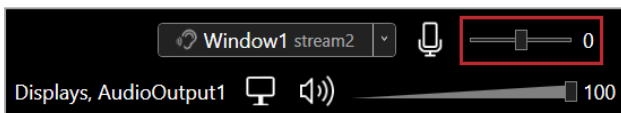

3. Select each source in turn and check the input audio level.





## Check if canvases or displays are cut to black and muted

1. Select  Dashboard.
2. If a canvas is cut to black and muted, restore it.
  - To cut a display to black and mute it, select 
  - To restore a display, select 
3. Select  Editor > Displays & Windows.

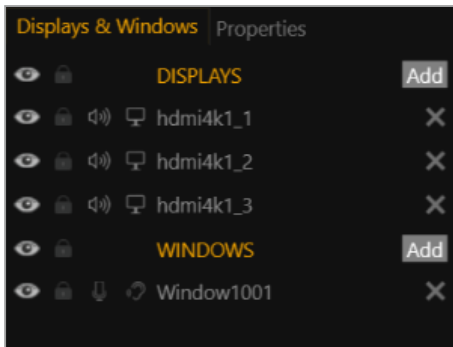
4. If a display is cut to black and muted, restore it.







- To cut a display to black and mute it, select .
- To restore a display, select .

 Only administrators and power users can restore individual displays. If a display is black and you can't hear audio, ask an administrator to check if it is cut to black and muted.

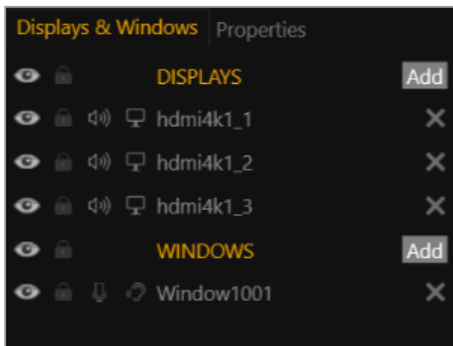

## Check if displays or windows are muted

1. Select  Editor > Displays & Windows.
2. If the display or window is muted, unmute it.



- To mute audio, select  or .
- To unmute audio, select  or .

## Check your presets

1. Select  Editor >  Show presets.

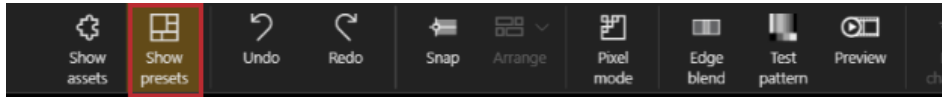

2. From  Presets, select a preset.

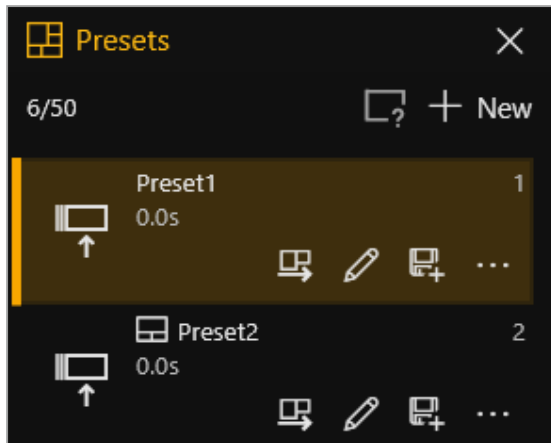

3. On the canvas, check which windows and sources appear in the preset.
4. Repeat for all presets.

Read more about best practice for using presets on page 66.

## Check the format of your media items

- Your CORIOmaster only supports two-channel audio, in uncompressed PCM format, at 48 kHz.
- Your CORIOmaster does not support surround sound.
- The Streaming media and 4K playback input module only supports .mp3 and .aac formats.
- If you have a media player connected to your S/PDIF and analog audio module, check that it can provide audio in uncompressed PCM format.
- If your media items are not supported, consider converting them.

## Then try this

1. Restart your CORIOmaster.
2. Check all hardware connections.
3. Check that your audio device is working. Try plugging in another source.
4. Make sure you are running the latest firmware and software.

Download the latest version of CORIOgrapher from [help.tvone.com/r/docs/g/software](http://help.tvone.com/r/docs/g/software).

Read about updating your firmware on page 128.

## Audio from the Streaming media and 4K playback input module

- To access the media player, page 142
- Check the format of your media items, page 142
- Check if your stream is playing with low latency, page 142

### To access the media player

1. In  Editor, double-click the window you wish to play streaming media, and select (Media Player) Manage.

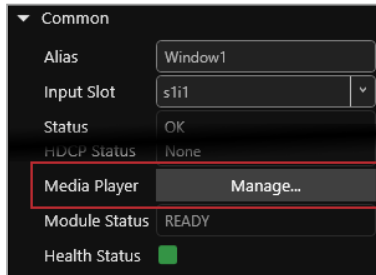

### Check the format of your media items

- The Streaming media and 4K playback input module only supports .mp3 and .aac formats, at 48 kHz.
- If your media items are not supported, consider converting them.

### Check if your stream is playing with low latency

1. In the play queue, select the stream.
2. Select  > Edit.

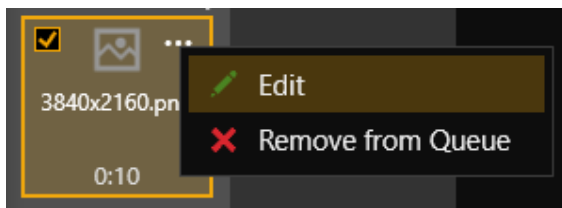

3. Check if Low latency is selected.

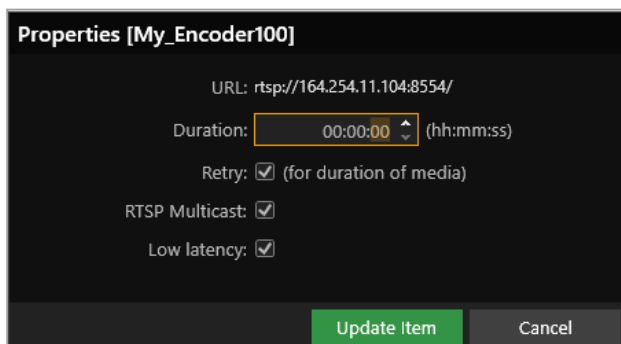

If you want to listen to audio from your stream, clear Low latency.

## Then try this

1. Restart your CORIOmaster.
2. Check all hardware connections.
3. Check that your audio device is working. Try plugging in another source.
4. Make sure you are running the latest firmware and software.

Download the latest version of CORIOgrapher from [help.tvone.com/r/docs/g/software](http://help.tvone.com/r/docs/g/software).

Read about updating your firmware on page 128.

## Audio from the S/PDIF output of a CORIOmaster micro

- Check which window is active, page 143
- Check if the source is muted or the input audio level is turned down, page 143
- Check if the output is muted, page 144
- Check that the button you pressed is mapped to the correct window, page 144

## Check which window is active

- On the front panel of your CORIOmaster micro, press and hold the button that corresponds to the window you want to hear, until it flashes red.

## Check if the source is muted or the input audio level is turned down

1. From  Editor, open the list of audio sources.

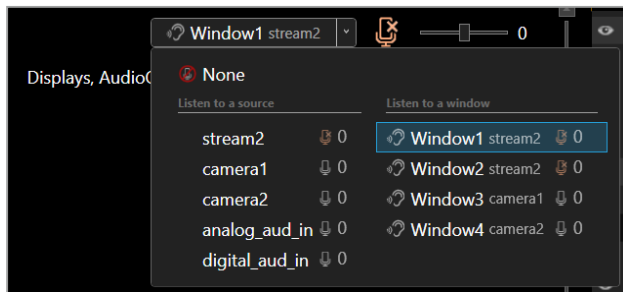

2. Select each source in turn and check if the source is muted, or the input audio level is set too low.

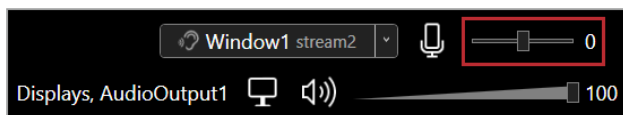
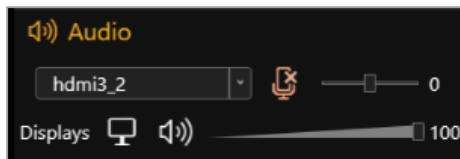

## Check if the output is muted

1. From the wall editor, select Audio.



2. Make sure the Mute Audio option is cleared.

## Check that the button you pressed is mapped to the correct window

1. In CORIOgrapher, select  > (Front Panel) Button Mapping.
2. In Window, check which window is mapped to the button you pressed.
3. If the window mapped to that button is not correct, you can choose a different window, or press a different button on the front panel.

## Then try this

1. Restart your CORIOmaster micro.
2. Check all hardware connections.
3. Check that your audio device is working. Try plugging in another source.
4. Make sure you are running the latest firmware and software.  
Download the latest version of CORIOgrapher from [tvone.com/software](http://tvone.com/software).  
Read about updating your firmware on page 128.

## If that doesn't work

If the advice here doesn't work, first contact your distributor. If your distributor can't help, contact tvONE support at [tech.usa@tvone.com](mailto:tech.usa@tvone.com) , [tech.europe@tvone.com](mailto:tech.europe@tvone.com) or [tech.asia@tvone.com](mailto:tech.asia@tvone.com).

# I can't update the firmware of my Streaming media and 4K playback input module

## What's the problem?

1. In CORIOdiscover, I have an error message that tells me one or more of my Streaming media and 4K playback input modules failed to update.
2. In CORIOgrapher™ I have an error message that tells me the firmware of my Streaming media and 4K playback input module failed to update. The module status is UPDATEFAILED.

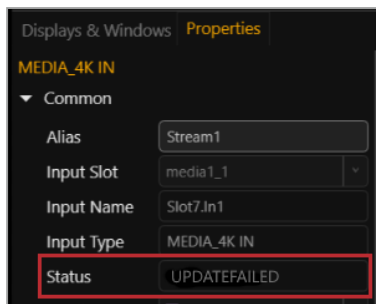

## Why does this happen?

- There was an error when you updated the firmware of your CORIOmaster™.
- The firmware download might be corrupted.
- There is a problem with a module.

## What to do

### First try this

1. Restart your CORIOmaster.
2. In CORIOgrapher, select ⚙ Settings > Module Configuration.
3. For each Streaming media and 4K playback input module, select ⋮ > Configure and check the status.

### Then try this

1. Download the firmware update again.  
Make sure you download the correct version for your CORIOmaster, CORIOmaster mini, or CORIOmaster micro.
2. Repeat the firmware update.

Read more about updating your firmware on page 128.

### If that doesn't work

If the advice here doesn't work, first contact your distributor. If your distributor can't help, contact tvONE support at [tech.usa@tvone.com](mailto:tech.usa@tvone.com), [tech.europe@tvone.com](mailto:tech.europe@tvone.com) or [tech.asia@tvone.com](mailto:tech.asia@tvone.com).

## General troubleshooting checklist

If specific troubleshooting advice isn't helping, or your product has stopped working, go through the points below. If your product still doesn't work, you might need to return it for repair.

Read about returning your product on page 146.

1. Make sure your product is set up correctly, as shown in this guide.
2. Check that your cables and equipment are all connected firmly.
3. Check that your product is connected to an electrical outlet that is switched on.  
Can you see LED lights on the front of your product?
4. Test your sources by connecting them directly to a display.
5. Test your display by connecting it directly to a source.
6. Test each cable.
7. Try restoring your product to factory default settings.  
Note: during factory reset your custom settings are deleted.
8. Try updating your firmware.  
Note: during a firmware update your custom settings are deleted.

## Returning a product for repair

You can request to return your product to tvONE™ for repair. When you contact tvONE support, have the following information ready.

- Product type
- Serial number of the faulty unit (this is on the underside of the unit)
- Full details of the issue
- Invoice number (if available)

Contact tvONE support for your area.

- Customers in North, Central, and South America (NCSA), email [tech.usa@tvone.com](mailto:tech.usa@tvone.com).
- Customers in Europe, the Middle East, and Africa (EMEA), email [tech.europe@tvone.com](mailto:tech.europe@tvone.com).
- Customers in Asia, email [tech.asia@tvone.com](mailto:tech.asia@tvone.com).

### EMEA and Asia

Customers in EMEA and Asia receive an RMA Request form from tvONE support. Complete the form and return it to tvONE support for your area.

### All customers

tvONE support decides if your product needs to return for repair, and, if needed, provide a return authorization number.

Send your product to tvONE by insured carrier or registered mail. Write your return authorization number on the outside of the packaging, and on any documents you send with your product.

You must arrange and pay for shipping and insurance. Products in transit are your responsibility. tvONE does not accept responsibility for products lost in transit.

 Do not return a product for warranty repair without a return authorization number. tvONE will not repair your product.

## What are the minimum requirements for running CORIOgrapher?

The minimum requirements for running CORIOgrapher are:

- Works with PCs running Windows® 10 and 11
- Does not work with touch-screen-only devices, including tablets or phones



- Works with Microsoft Surface Pros and similar touch screen devices  
Full support for touch screen devices is under development
- Installs Windows .NET 4.6, if you don't have it
- Needs 600 MB of disk space during installation
- Is approximately 60 MB in size once installed

To use the preview feature, your PC must have Windows Media Player installed, and it must have been launched at least once. Preview performance depends on the specifications of your PC and number of windows in your installation.

## What's the password for my CORIOmaster™?

The default administrator username and password for CORIOgrapher™ are `admin` and `adminpw`.

## Can I use HDMI extenders with CORIOmaster™ output modules?

See our range of HDMI extenders at [help.tvone.com/r/docs/g/signal-extension](http://help.tvone.com/r/docs/g/signal-extension).

## Where can I put Streaming media and 4K playback input modules?

The number of Streaming media and 4K playback input modules you can have, and where you can install them, depends on the CORIO unit you have.

### CORIOmaster™ series

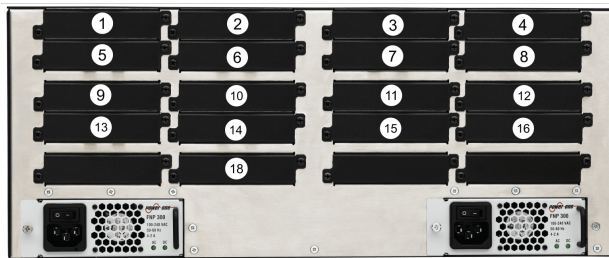

In a CORIOmaster, only slots 4, 8, 5, 1, and 3 can contain Streaming media and 4K playback input modules.

For best results, fit in the order given above.



In a CORIOmaster mini, only slots 1 and 2 can contain Streaming media and 4K playback input modules.



In a CORIOmaster micro, only slots 1 and 2 can contain Streaming media and 4K playback input modules.

## How large is the internal storage on a Streaming media and 4K playback input module?

There are two models of Streaming media and 4K playback input module. One comes with 16 GB of internal storage, the other comes with 128 GB.

## How do I find the MAC address of my Streaming media and 4K playback input module?

You can find the MAC address in Networking. Select  Settings > Module Configuration, find the module, and select  > Configure.

## How fast is my connection to the Streaming media and 4K playback input module?



You can find the connection speed in Networking. Select  Settings > Module Configuration, find the module, and select  > Configure.

## Which media formats can I add to a play queue?

You can add media streams, video clips, and still images to a play queue. For the full list of supported formats, see the specification sheet.

Specification sheets can be found on our website [tvone.com](http://tvone.com).

## Can I save my play queue?

If you add media items or streams to a play queue and select  Editor >  Set device startup, when you restart your CORIOmaster™, the media items and streams remain in the play queue.

You can save your play queue as a playlist.



Read more about playlists on page 109.

You can save all your settings, including your play queue, to a backup file on your CORIOmaster. If you want to load the same play queue at a later date, you can restore your settings from the backup file. Note: you will lose any work that you have done since creating the backup file.

## How do I mute audio?

If it's an emergency, the fastest way to mute everything is to use the emergency button for mute and cut to black.

In CORIOgrapher, select  Dashboard.

- To cut to black and mute all displays and outputs, select .
- To restore all displays and outputs, select .

If it's not an emergency, there are several other ways to mute audio. You can:

- Mute a source.  
Read more on page 87.
- Mute a display.  
Read more on page 89.
- Disable a source or display.  
Read more on page 82.
- Cut a display to black, which also mutes the audio.  
Read more on page 89.

## More

### In this section

What's new in CORIOgrapher™ V3.4 for CORIOmaster™ .....	149
Regulatory compliance for CORIOmaster™, CORIOmaster mini™, CORIOmaster micro™, Magenta Encoder-100, and all modules .....	149
Contact us .....	150

## What's new in CORIOgrapher™ V3.4 for CORIOmaster™

### CORIOgrapher V3.4

- Support for CORIOmaster™
- New look interface with dedicated panels for presets and assets
- New system and canvas level settings
- New preset editor, so you can select which windows are included in the preset.

For the full list of new features and things we've fixed, see the release notes.

Release notes are available at [help.tvone.com/r/docs/g/software](http://help.tvone.com/r/docs/g/software).

## Regulatory compliance for CORIOmaster™, CORIOmaster mini™, CORIOmaster micro™, Magenta Encoder-100, and all modules

This product has been tested for compliance with appropriate FCC and CE rules and regulations. The power adapter or supply has been tested for compliance with appropriate UL, CUL, CE, PSE, GS, rules, regulations and/or guidelines. This product and its power adapter or supply is RoHS compliant.

### WEEE directive



The wheeled bin symbol on this product or its packaging indicates that this product shall not be treated as household waste. In line with EU Directive 2012/19/EU for waste electrical and electronic equipment (WEEE), this electrical product must not be disposed of as unsorted municipal waste. Dispose of this product by returning it to the point of sale, or to your local municipal collection point for recycling. Doing this helps conserve our environment.

## Contact us

tvone.com

info@tvone.com

### tvONE NCSA

North, Central, and South America

 621 Wilmer Avenue, Cincinnati, Ohio 45226 USA

---

 Tel +1 513-666-4210

---

 Sales: sales@tvone.com  
Support: tech.usa@tvone.com

### tvONE EMEA

Europe, Middle East, Africa, and Asia Pacific

 Unit V Continental Approach, Westwood Industrial Estate, Margate, Kent, CT9 4JG, UK

---

 Tel +44-1843-873311

---

 Sales: sales.europe@tvone.com  
Support: tech.europe@tvone.com

### tvONE Asia

Asia

 Sales: sales.asia@tvone.com  
Support: tech.asia@tvone.com

Information in this document is subject to change without notice. No part of this publication may be reproduced, stored in a retrieval system, or transmitted in any form or any means electronic or mechanical, including photocopying and recording for any purpose other than the purchaser's personal use without the written permission of tvONE.

Copyright © 2022 tvONE™. All rights reserved.

Registered in the U.S. Patent and Trademark Office.